

CORBY
OF WINDSOR



DESIGNED FOR HOTELS

RELAX, IT'S COVERED



**ELECTRICAL
GUARANTEE**



Terms and Conditions Apply: Up to 4 Year Electrical Guarantee applies to all mains operated electrical items only. This covers failure due to electrical defects and does not cover wear and tear due to excessive use. The Electrical Guarantee is applied automatically at purchase, no sign up required. For the full list of Terms and Conditions please visit www.corbyofwindsor.com

CONTENTS

03

Introduction

A brief overview of who we are and what we are about.

05

Our Story

Our story from where we started and a timeline of our company milestones.

07

A Culture of Excellence

A section all about the values of our team & the excellent global support they offer.

09

What We Do

A brief overview of our key design principles and what we do here at Corby of Windsor.

15

Essentials by Corby

Practical and affordable products for the hotel guest room.

17

Ironing

Explore our garment care collection; safe, durable and timeless by design.

29

Kettles, Espresso Machine & Trays

Relax & enjoy our latest hospitality range, where functionality meets elegance.

49

Hair Dryers

Our hair dryer collection offers high end luxury alongside eco focused design.

59

Minibars

Explore our refreshing minibar collection; designed to fit a variety of spaces.

69

Safes

Discover a safer guest experience with our hotel safes collection.

75

Bedroom Items

Our bedroom items are the perfect addition to enhance your guests stay.

89

Bathroom Items

Unwind with our range of stylish, easy to clean bathroom items.

KEY OF SYMBOLS

- New Product
- Eco Friendly
- British Design
- 4 Year Guarantee
- USA Approved
- 2 Year Guarantee
- Accessibility Friendly
- Made of BUSA bamboo

CORBY OF WINDSOR

Specialists in electricals for the hotel guest room

We at Corby of Windsor specialize in the design, manufacture and supply of hotel guest room products. With decades of experience in producing electrical appliances, we have the knowledge necessary to ensure our products are not only produced to a consistent standard but they are also appropriately accredited and certified for the markets they serve. We export to over 60 countries worldwide and are specified in many branded hotel chains.



CORBY OF WINDSOR

Established in 1930

Incorporated originally by Mr John Corby in Windsor in 1930, Corby of Windsor is famous for its' garment care products, particularly the pants press. Over the years, Corby has expanded into the manufacture of electrical products within the garment care category becoming a household name in the 1980s as its' products are procured by hotels around the world.



In 2009

Corby of Windsor was acquired by Fired Up Corporation

Fired Up Corporation Ltd is a global manufacturer and direct sourcing expert, with multiple factories and distribution centers around the world. Its expertise is within electrical appliances, operating under 10 product brands and producing over 500,000 products per year.



OUR STORY

- 1930 Pants Press manufacturing begins in Windsor, UK.
- 1950 Corby invents the worlds first electric Pants press.
- 1980 Over 100,000 electric presses are sold in one year.
- 2000 Corby of Windsor expand the range of hotel electrical products to include irons and ironing centers, kettles and ancillary products.
- 2009 Fired Up Corporation purchase Corby of Windsor and utilising our extensive design and production facilities expands the range further, to include minibars, hairdryers, safes and scales.
- 2010 A broad range of welcome trays are introduced including the world's first ever drip tray option.
- 2011 Global expansion continues and distributors are appointed in the Middle East and Asia.
- 2012 Another product first, the 180° iron holding brackets are introduced to our ironing centers.
- 2015 Alliances with some of the worlds biggest brands ensure we have a global presence and Corby products are now exported to over 60 countries worldwide.
- 2018 Corby of Windsor collaborate with Nescafé on the Buckingham Compact Welcome Tray.
- 2021 Canterbury collection is introduced – Over 96 Welcome tray comwastebasketations.
- 2022 Corby of Windsor introduces the worlds highest rated glass door minibar with the Eton E.
- 2023 New distribution CENTER opens in Czechia to service customers in Europe.
- 2024 Corby of Windsor introduces a range of eco-friendly solutions including the Skye high speed hair dryer as well as the Thornton and Newport recycling collection.
- 2025 Introduced the innovative Darlington Garment Mat as well as the new Essentials by Corby range.

OUR STORY 06

The Pants Press invented by Mr John Corby in Windsor in 1930.

A CULTURE OF EXCELLENCE

For almost 100 years, Corby of Windsor has been devoted to delivering exceptional service for customers worldwide.

As a leading manufacturing brand in the hotel and hospitality industry, our success depends on the quality of our work, attitude, expertise, innovation, and how we treat people. Our dedicated business development and account management team are here to serve you.

In everything we do, our team upholds the following principles;



COMMITMENT

Our brand represents our reputation. We are devoted to maintaining the supply of world-class products and services to our customers worldwide. We strive to build sustainable partnerships that continue to reflect and strengthen the integrity of the Corby of Windsor name.



PASSION

We design, source and manufacture products that are specifically created for the hotel guest room. We rely on customers to help us find the next opportunity, which keeps every relationship fresh and every new project exciting.



EMPATHY

We are receptive to the needs of our customers. Our customers are our eyes, ears and voice in the market and their needs guide our focus.



EXPERTISE

We have vast experience in knowing when, where and how to add value for our customers. Our multicultural, highly-skilled team are trained in design, production and international trade and global supply chain operations to ensure we meet and exceed our customers requirements.

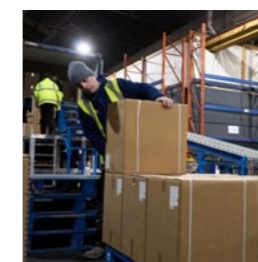
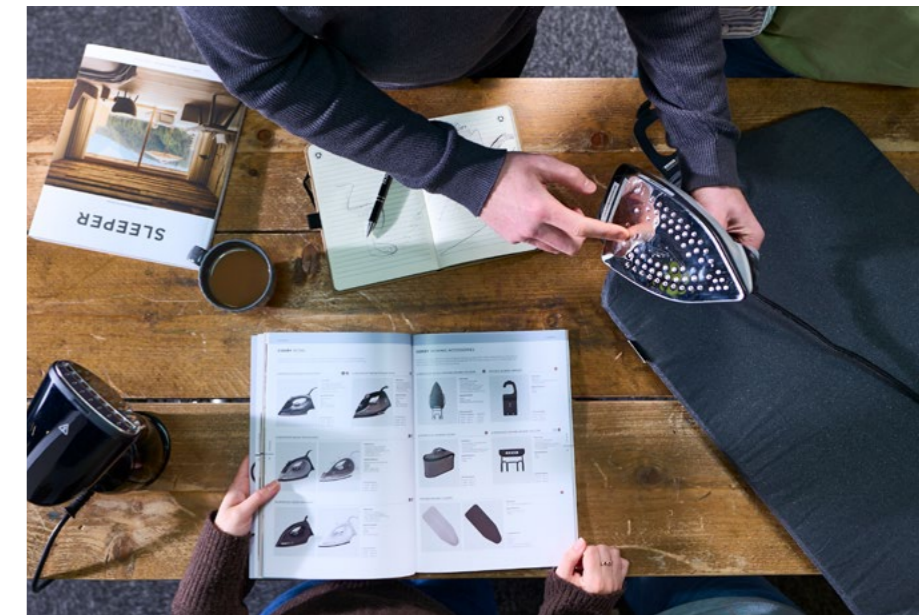

🇬🇧 DESIGNED FOR HOTELS

Our UK team of designers have worked with architects, interior designers and furniture manufacturers to create an attractive and versatile range, designed for hotels. We are selective in the materials we use and ensure each product is tested with the hotel and guest in mind.

Over the years, we have influenced the industry with our creative thinking and unique safety solutions to set the standard in guest room electricals, and work continuously to evolve our range.

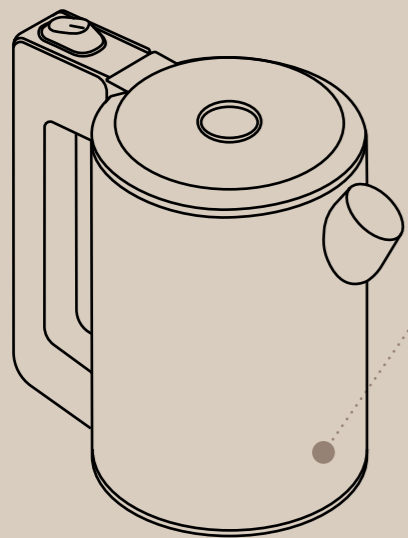

CANTERBURY 0.6L KETTLE
Hotel specific 0.6L kettle design

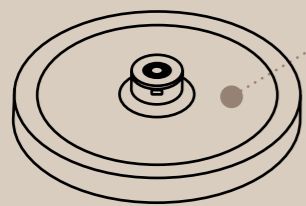

DUAL KETTLE BASE (0.6L & 1L)
Innovative interchangeable kettle base

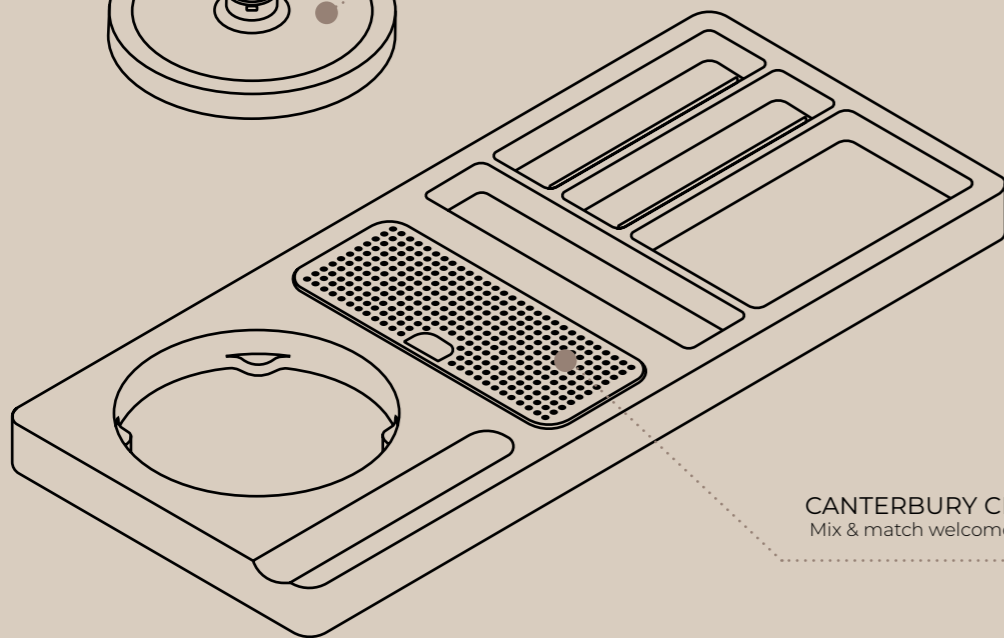

CANTERBURY CLASSIC WELCOME TRAY
Mix & match welcome tray design for 0.6L & 1L kettles

STAINLESS STEEL DRIP TRAY
Innovative design introduced in 2009



4 ENGINEERED TO LAST

We look at all aspects of construction, materials and 'life testing' to ensure we have the best products for the market. We understand the needs of the customer, so we implement strict measures throughout the manufacturing process in our factories to ensure our products meet the high standards we set ourselves.

Our Guarantee on electrical products supports this philosophy.



WHAT WE DO

11

 **GLOBAL SUPPLY & SUPPORT**

We have high levels of stockholding and logistics capabilities in UK, EU, USA and China with direct shipping options and stockholding distributors in key growth territories.

We have significant competence in international certification and accreditation, with considerable experience in export and distribution of electrical products worldwide.



WHAT WE DO

12

 **HOTEL SPECIFIED**

Our specialized range of hotel electricals & accessories is ever-evolving alongside styles & trends we see around the world, which is why we are confident we can accommodate any guest room environment.

This is why our products are specified for many of the world's largest hotel chains, making the introduction to our pre-approved product range a simpler and speedier process.



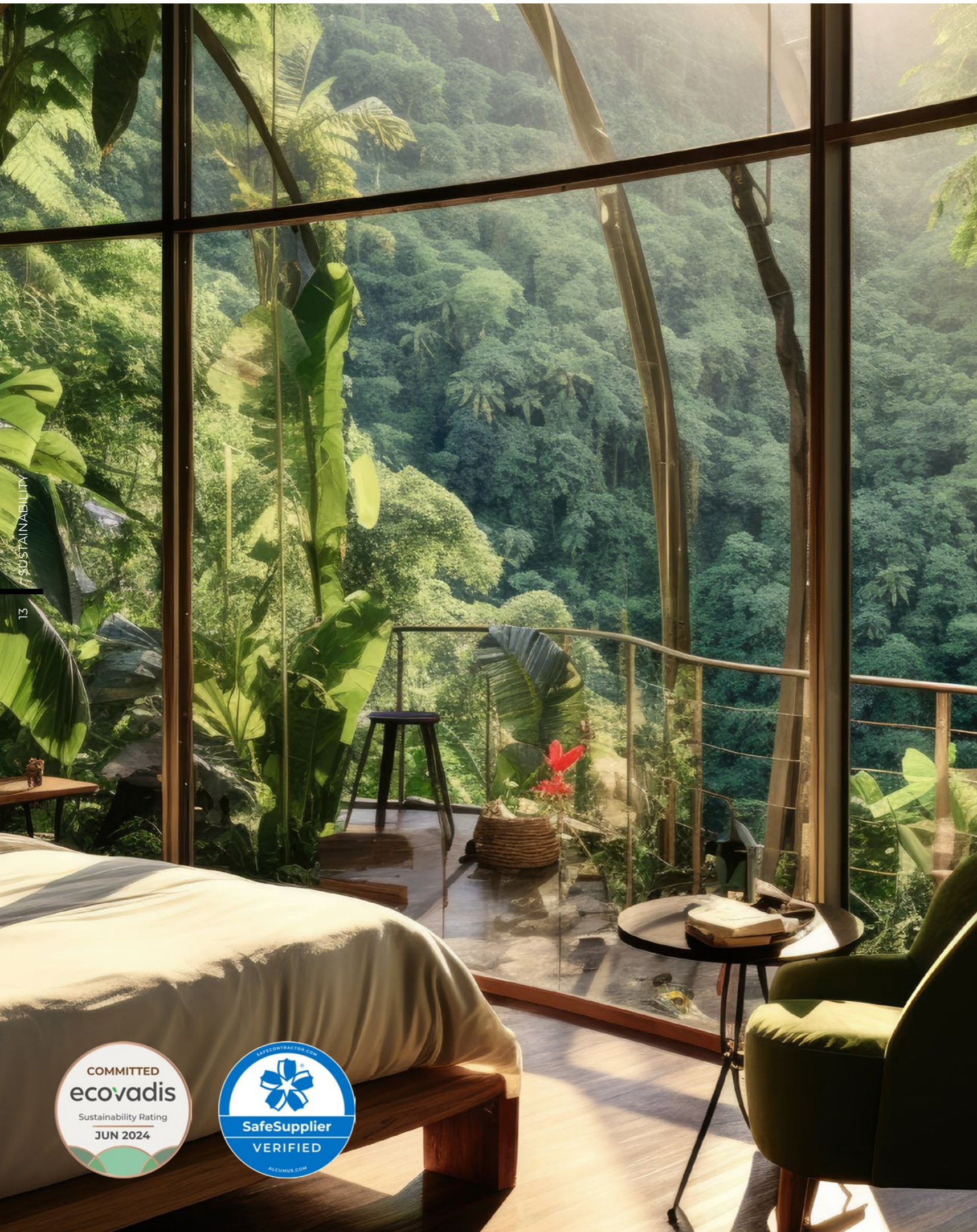

SUSTAINABILITY FOCUSED

Corby of Windsor recognises the value in identifying and minimizing the environmental impact of our products and operations. We remain committed to the continuous improvement of our sustainability performance to protect the planet for current and future generations.

As a designer and producer, we look at all aspects of the product life cycle, from the materials we use to how our products are manufactured. We continue to challenge conventional production methods to better suit the customer & the environment.

In recent years we have:



Improved the assembly process to be more user friendly for local repair. We have also increased the availability of spare parts across the range.



Prevented 82,000 toxic chrome plated items entering the market by finding eco-friendly finishing methods.
*Data taken between 31/8/23 - 1/9/24



Joined the World's most trusted sustainability business rating Ecovadis. We are also verified with Alcumus SafeSupplier.



Introduced the Skye hair dryer which dries hair twice as fast whilst using 58% less energy*
*Based on testing against the Bedford 2000W hair dryer.



Expanded our range of recycling options to offer up to 28 guestroom waste solutions.



Introduced the BUSA range of trays and accessories, made from the worlds most sustainable material, bamboo.

We have ambitious plans to become a net zero company by 2036 and we are committed to drive change throughout the business and help reduce the impact to the environment within the hospitality industry.



essentials

by CORBY

Essentials by Corby is a streamlined range of guest room products designed with affordability in mind. As a sub-brand of Corby, it reflects our commitment to safety, reliability, and value while delivering practical, cost-effective solutions without compromising on quality.

Essentials products undergo the same rigorous testing and quality assurance processes that define the Corby brand and are readily available through our international distribution network.

Typically unbranded, Essentials by Corby products are designed with a focus on functionality and simplicity, in contrast to the innovation-led approach of the main Corby range. Each item is supported by a two-year electrical guarantee, ensuring dependable performance for everyday guest room requirements.

Essentials by Corby: Practical, Affordable Guest Room Solutions



2-year guarantee on electricals

Following the same in-house test procedures throughout development, Essentials products are functional and reliable. That's why we offer a 2-year guarantee on electricals.



Minimal branding

Essentials products are typically unbranded, allowing hotels to maintain a consistent and uncompromised brand identity throughout the guest room. The same minimalist approach extends to the packaging, which features plain boxes with only the necessary information required for export and legal compliance.



Affordable

We work with our OEM (Own Equipment Manufacturer) partners to offer a range of products where investment in tooling and new certification is minimised, resulting in affordable solutions for the hotel guest room.



Supplied & supported by Corby

As a sub-brand of Corby, Essentials offers the same exceptional service and support delivered by our international team. Products are stocked and distributed through the same trusted global distribution centers, ensuring reliable availability and consistency.





CORBY IRONING COLLECTION

As experts in garment care for over 90 years, our specialized range offers attractive solutions that are engineered to be functional, durable & safe. From all-in-one ironing centers to compact ironing boards, we are confident we have the perfect comwastebasketation to suit your guest room.

SWING INTO ACTION

Originally invented by Corby of Windsor, the 180° iron holder has set the standard in guest room ironing. We have evolved all of our ironing centers to be effortless to use as well as space-saving. We have also revolutionized the manufacturing process for this, reducing the total number of parts required and completely removing the need for chrome plating.





3-way cut-off

All Corby irons are programmed with a 3-way cut-off, designed to keep both guests and hoteliers safe if an iron is left unattended.

SAFE & SECURE

All Corby irons are programmed to have a 3-way cut-off feature, so hoteliers have peace of mind if an iron is left unattended. The iron will simply switch off after 30 seconds if left horizontally or 8 minutes if left vertically.

Our all-in-one ironing centers are a great example of form and function. Everything you need is attached to the center, making ironing safe and convenient. Each center is fitted with a cable tidy system and an anti-theft device to help prevent irons from being stolen.



Anti-theft

All Corby of Windsor ironing centers are fitted with an anti-theft device to help prevent irons being stolen.

TAILOR MADE SOLUTIONS

Corby of Windsor has been manufacturing quality garment care products since 1930. Our specialized range of hotel electricals & accessories is ever-evolving alongside styles & trends we see around the world, which is why we are confident we can accommodate any guest room environment.



Table Top



Darlington



Cambridge



Berkshire



Oxford



Classic

CORBY OXFORD IRONING COLLECTION

Specifically designed for hotels, the Oxford range offers full-size ironing solutions featuring a sleek, surfboard-style board design. With quick-release handles on both sides, the Oxford is user-friendly and convenient for both left- and right-handed guests.

OXFORD IRONING CENTER / Steam or Dry

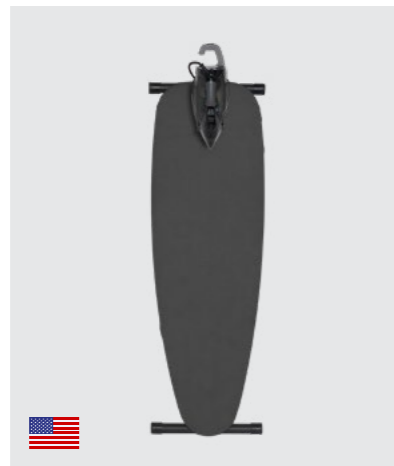
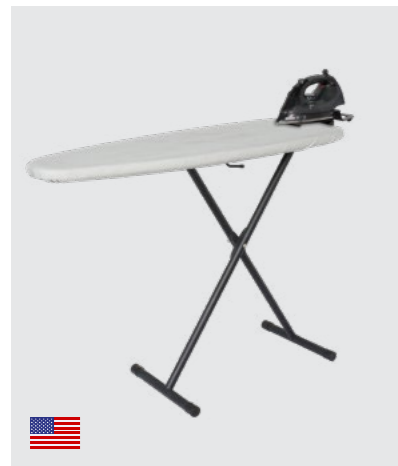

Features:

- Compatible with Sherwood 1100W Steam Iron
- Integrated hanger & cable tidy
- Easy open mechanism
- Anti-theft security box
- 3-way auto cut-off system

Specification:

Light Grey / Dark Grey
5.15kg - 5.90kg
2.5m - 3m cable length
*Iron & Iron holder supplied separately

Dimensions:

| (Board Open) | (Board Closed) |
|----------------------|-----------------|
| Height - 590 - 840mm | Height - 1270mm |
| Width - 1015mm | Width - 360mm |
| Depth - 340mm | Depth - 265mm |

OXFORD IRONING BOARD WITH HANGER

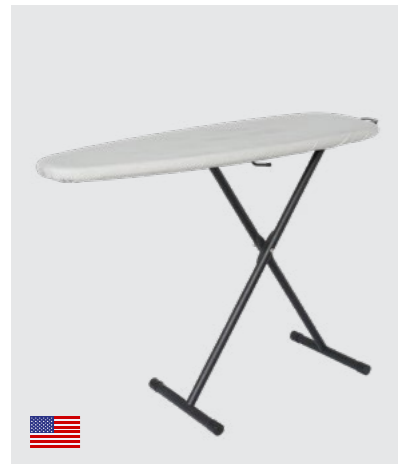

Features:

- Durable powder coated legs and frame
- Easy open mechanism
- Lightweight design
- 7 height positions
- Burn-proof aluminized cover

Specification:

Light Grey / Dark Grey
3.70kg
*Ironing Board Hanger supplied separately

Dimensions:

| (Board Open) | (Board Closed) |
|----------------------|-----------------|
| Height - 590 - 840mm | Height - 1220mm |
| Width - 1100mm | Width - 360mm |
| Depth - 340mm | Depth - 70mm |

OXFORD IRONING BOARD



Features:

- Durable powder coated legs and frame
- Easy open mechanism
- Lightweight design
- 7 height positions
- Burn-proof aluminized cover

Specification:

Light Grey / Dark Grey
3.50kg

Dimensions:

| (Board Open) | (Board Closed) |
|----------------------|-----------------|
| Height - 590 - 840mm | Height - 1125mm |
| Width - 1100mm | Width - 360mm |
| Depth - 340mm | Depth - 70mm |

CORBY BERKSHIRE IRONING COLLECTION

Specifically designed for hotels with limited storage, the Berkshire range offers a compact, space-saving solution that combines practicality and convenience, ensuring guests enjoy seamless usability without compromising on functionality.

BERKSHIRE IRONING CENTER / Steam or Dry

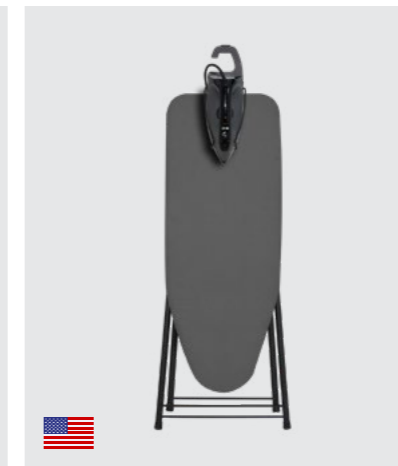

Features:

- Compatible with Sherwood 1100W Steam Iron
- Integrated hanger & cable tidy
- Deck chair mechanism
- Anti-theft security box
- 3-way auto cut-off system

Specification:

Light Grey / Dark Grey
4.65kg - 4.80kg
2.5m - 3m cable length
*Iron & Iron holder supplied separately

Dimensions:

| (Board Open) | (Board Closed) |
|----------------|-----------------|
| Height - 755mm | Height - 1135mm |
| Width - 895mm | Width - 400mm |
| Depth - 340mm | Depth - 210mm |

BERKSHIRE IRONING BOARD WITH HANGER

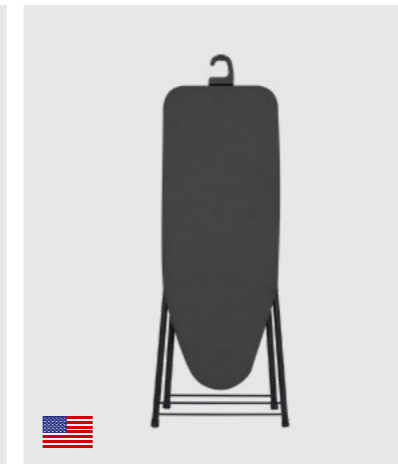

Features:

- Durable powder coated legs and frame
- Deck chair mechanism
- Lightweight design
- Burn-proof aluminized cover

Specification:

Light Grey / Dark Grey
3.20kg
*Ironing Board Hanger supplied separately

Dimensions:

| (Board Open) | (Board Closed) |
|----------------|-----------------|
| Height - 755mm | Height - 1115mm |
| Width - 895mm | Width - 400mm |
| Depth - 340mm | Depth - 50mm |

BERKSHIRE IRONING BOARD

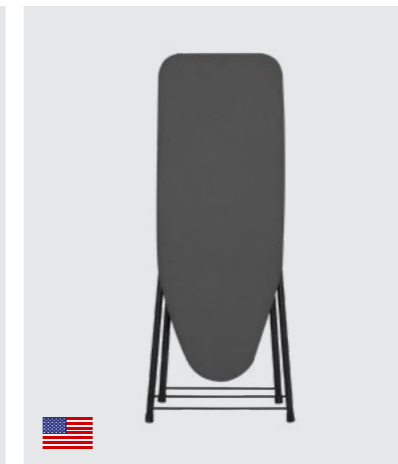
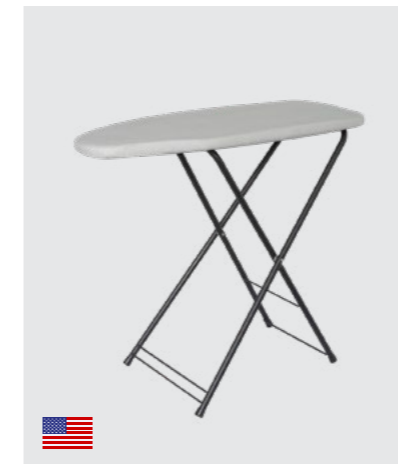

Features:

- Durable powder coated legs and frame
- Deck chair mechanism
- Lightweight design
- Burn-proof aluminized cover

Specification:

Light Grey / Dark Grey
3kg

Dimensions:

| (Board Open) | (Board Closed) |
|----------------|-----------------|
| Height - 755mm | Height - 1000mm |
| Width - 895mm | Width - 400mm |
| Depth - 340mm | Depth - 50mm |

CORBY SUTTON TABLE TOP IRONING COLLECTION

When space is limited, the Sutton Table Top range offers a full ironing solution that's effortless to use. With a fixed-leg design, there's no need for unfolding, just place it on a surface and it's ready to go.

SUTTON TABLE TOP IRONING CENTER / *Steam or Dry*

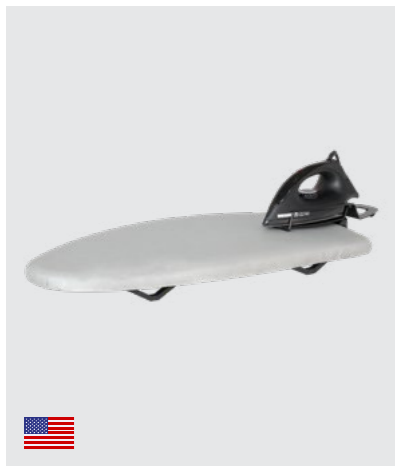

- Features:**
- Compatible with Sherwood 1100W Steam Iron
 - Integrated hanger & cable tidy
 - Compact board size
 - Anti-theft security box
 - Fixed ABS legs
 - 3-way auto cut-off system

Specification:
 Light Grey
 3.40kg - 4kg
 2.5m - 3m cable length
 *Iron & Iron holder supplied separately

Dimensions:
 Height - 250mm
 Width - 910mm
 Depth - 345mm

CORBY GARMENT MAT & IRONING BOARDS

Designed with hotel guests in mind, Corby offers a versatile range of alternative ironing solutions, including an innovative garment mat, a space-saving wall-mounted option, and other thoughtfully engineered designs to suit a variety of room layouts and guest needs.

IRONING BOARD (CLASSIC / IB0007)



- Features:**
- Durable powder coated legs and frame
 - 7 height positions
 - Easy open mechanism
 - Lightweight design
 - Built-in iron rest
 - Burn-proof aluminized cover

Specification:
 Dark Grey / Light Grey
 1.50kg

Dimensions:

| (Board Open) | (Board Closed) |
|----------------------|-----------------|
| Height - 665 - 835mm | Height - 1240mm |
| Width - 940mm | Width - 360mm |
| Depth - 330mm | Depth - 65mm |

SUTTON TABLE TOP IRONING BOARD WITH HANGER



- Features:**
- Durable powder coated legs and frame
 - Fixed ABS legs
 - Lightweight
 - Burn-proof aluminized cover
 - Protective rubber feet

Specification:
 Light Grey
 1.92kg
 *Ironing Board Hanger supplied separately

Dimensions:
 Height - 77mm
 Width - 875mm
 Depth - 345mm

DARLINGTON GARMENT MAT



- Features:**
- Integrated hook & hanger
 - Double sided garment mat
 - Suitable for ironing & steaming
 - Burn-proof aluminized cover
 - Lightweight & slim line design

Specification:
 Dark Grey
 1.50kg

Dimensions:
 Height - 995mm
 Width - 420mm
 Depth - 60mm

CAMBRIDGE IRONING BOARD / *Wall Mounted*



- Features:**
- Wall mounted
 - Space saving design
 - Easy to open
 - Burn-proof aluminized cover

Specification:
 Dark Grey
 6kg

Dimensions:
 Height - 805mm
 Width - 350mm
 Depth - 50mm - 733mm

SUTTON TABLE TOP IRONING BOARD



- Features:**
- Durable powder coated legs and frame
 - Fixed ABS legs
 - Lightweight
 - Burn-proof aluminized cover
 - Protective rubber feet

Specification:
 Light Grey
 1.72kg

Dimensions:
 Height - 77mm
 Width - 770mm
 Depth - 35mm

TABLE TOP IRONING BOARD (IB0009)

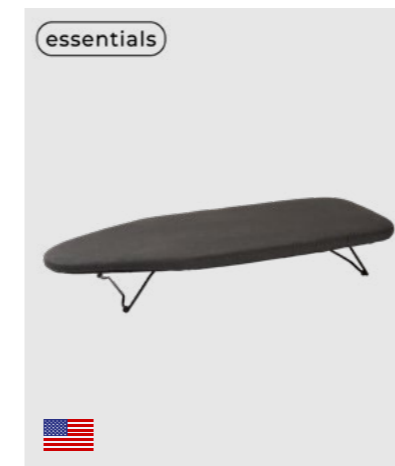

- Features:**
- Slimline design
 - Easy open mechanism
 - Lightweight
 - Burn-proof aluminized cover
 - Protective rubber feet

Specification:
 Dark Grey
 0.91kg

Dimensions:
 Height - 33mm - 120mm
 Width - 772mm
 Depth - 318mm

CORBY GARMENT STEAMER & IRONS

Corby offers a range of dry and steam irons from 1200W to 2000W, all engineered with a safety-focused auto shut-off system (8 minutes upright / 30 seconds horizontal) for reliable, hassle-free use. For guests on the go, the Stockton Garment Steamer provides a convenient and easy-to-use alternative.

STOCKTON GARMENT STEAMER

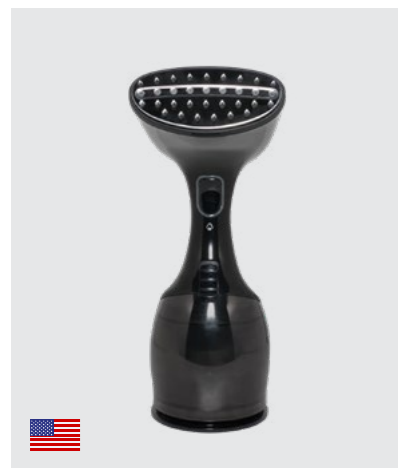

- Features:**
- Non-stick stainless steel plate
 - Continuous steam rate 20-25g
 - Trigger activated - 2x steam settings
 - 270ml detachable water tank
 - Auto cut-off after 1 min

Specification:
 Black
 1.10kg
 1200W
 120V
 3m cable length

Dimensions:
 Height - 295mm
 Width - 115mm
 Depth - 145mm



SHERWOOD 2000W STEAM IRON



- Features:**
- Stainless steel soleplate
 - Self cleaning function
 - Adjustable temperature dial
 - Hotel safety iron
 - 3-way auto cut-off

Specification:
 Black & Grey
 1.20kg
 2000W
 330ml water tank
 3m cable length

Dimensions:
 Height - 160mm
 Width - 290mm
 Depth - 117mm

CORBY IRONING ACCESSORIES

Corby accessories complete the ironing package with a selection of stylish, functional storage solutions designed for guest rooms. Several options include anti-theft features, offering added peace of mind for hoteliers.

BRIXTON IRON & STEAMER CADDY



- Features:**
- Heat resistant reinforced base
 - Cord tidy storage
 - Carry handle
 - Suitable for hanging on Corby hooked boards
 - Accommodates all Corby irons & the Stockton garment steamer

Specification:
 Dark Grey & Black
 0.25kg

Dimensions:
 Height - 302mm
 Width - 302mm
 Depth - 22mm



SHERWOOD IRON & IRONING BOARD HOLDER

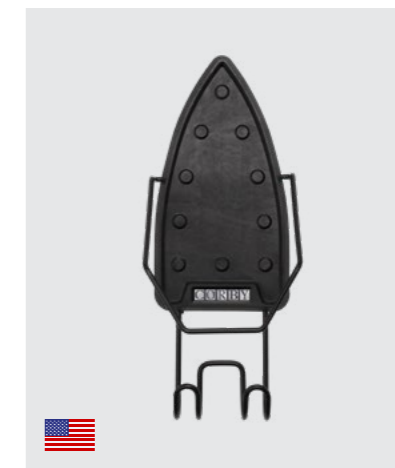

- Features:**
- Wall mounted holder
 - Concealed fixings
 - Rigid & durable construction
 - Heat resistant resting plate
 - Full sole plate protection
 - Accommodates all Corby irons

Specification:
 Black
 0.30kg - 0.40kg

Dimensions:
 (1100W) (1600W/2000W)
 Height - 335mm Height - 380mm
 Width - 130mm Width - 140mm
 Depth - 110mm Depth - 125mm



SHERWOOD 1100W STEAM IRON



- Features:**
- Stainless steel soleplate
 - Compact & lightweight
 - Adjustable temperature dial
 - Hotel safety iron
 - 3-way auto cut-off

Specification:
 Black & Grey
 0.75kg
 1100W
 120V
 145ml water tank
 2.5m cable length

Dimensions:
 Height - 120mm
 Width - 250mm
 Depth - 105mm



SHERWOOD 1200W DRY IRON



- Features:**
- Non-stick soleplate
 - Compact & lightweight
 - Adjustable temperature dial
 - Hotel safety iron
 - 3-way auto cut-off

Specification:
 Black
 0.60kg
 1200W
 2.5m cable length

Dimensions:
 Height - 120mm
 Width - 250mm
 Depth - 105mm

SHERWOOD IRONING BOARD HOLDER



- Features:**
- Wall mounted holder
 - Concealed fixings
 - Rigid & durable construction
 - Accommodates all Corby ironing boards except Sutton

Specification:
 Black
 0.10kg

Dimensions:
 Height - 90mm
 Width - 100mm
 Depth - 45mm



IRONING BOARD HANGER

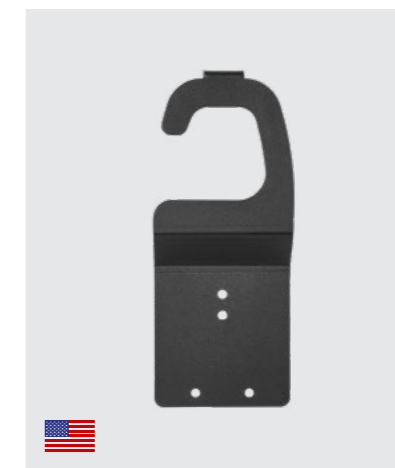

- Features:**
- Easy to fit
 - Compatible with Oxford, Berkshire & Sutton

Specification:
 Black
 0.20kg

Dimensions:
 Height - 186mm
 Width - 75mm
 Depth - 25mm



1600W STEAM IRON (Y-879)

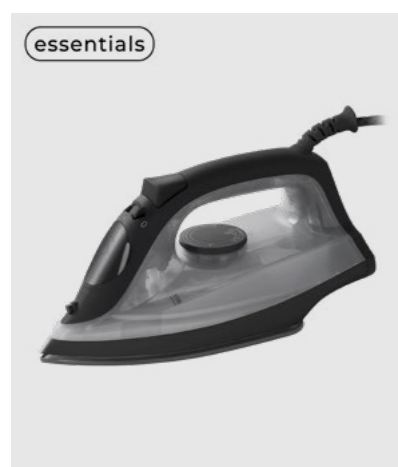

- Features:**
- Ceramic sole plate
 - Self-cleaning function
 - Adjustable temperature dial
 - Hotel safety iron
 - 3-way auto cut-off

Specification:
 Black & Grey
 0.90kg
 1600W
 180ml water tank
 2.5m cable length

Dimensions:
 Height - 110mm
 Width - 250mm
 Depth - 165mm

essentials

DURHAM HOLDER

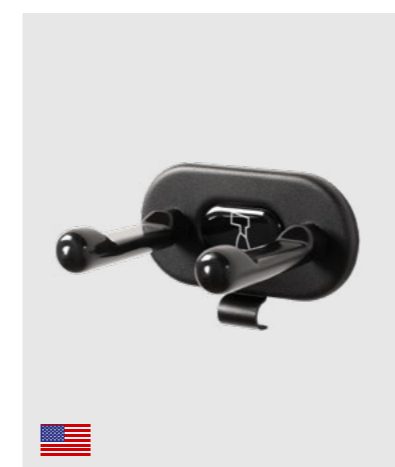

- Features:**
- Wall mounted with optional anti-theft feature
 - Durable steel construction
 - Concealed fixings with product icon
 - Anti-scratch protection
 - Compatible with Stockton Garment Steamer

Specification:
 Black
 0.29kg

Dimensions:
 Height - 69mm
 Width - 110mm
 Depth - 81mm



IRONING CENTER HOLDER



- Features:**
- Integrated hook
 - Durable powder coated finish
 - Original 180° rotating design
 - Protective silicone plate
 - Compatible with Oxford, Berkshire & Sutton

Specification:
 Black
 0.86kg
 Option A - 1100W Irons
 Option B - 1600W & 2000W Irons

Dimensions:
 Height - 91mm
 Width - 120mm - 130mm
 Depth - 314mm





CORBY ESPRESSO MACHINE, KETTLES & TRAYS

Designed for hotels, our eco-friendly kettles & trays are available in a wide range of sizes, finishes and styles. Our welcome trays with their innovative drip tray feature have shaped the industry, providing guests with everything they need to make a relaxing hot drink.

A WARM WELCOME

A warm drink is a great way to start the day. Feel relaxed and assured that Corby of Windsor will not let you down. With decades of experience in designing and manufacturing electrical products for the hotel industry, we understand what our customers require of us; that's why we offer up to a 4 year guarantee on all electrical products.



British Designed

Our products are designed by our UK based team of product developers in collaboration with international engineering teams. The team examines all aspects of construction, materials and 'life testing' to ensure we have the best possible offering in terms of value & serviceability for hoteliers.

RELAX & SWITCH OFF

Corby kettles have been engineered with world-leading Strix Technology. Strix thermal controllers are manufactured to exceed 12,000 cycles of normal operation, so hoteliers & guests will have peace of mind that their kettles will perform.



Strix Technology

Corby kettles are engineered with world leading thermal control technology.



Lift Off Reset

Corby Kettles are fitted with an additional safety system that only allows the kettle to dry boil once. This feature is designed to keep both guests and hoteliers safe if a kettle is left to dry boil unattended.

CORBY KETTLES

Engineered with world-leading Strix thermal control technology, our kettles are available in a variety of colours and sizes, with matching welcome trays to complement any room design. Designed specifically for hotel guests, they feature concealed heating elements and 360° swivel bases, making them both easy to use and effortless to clean.

CANTERBURY 0.6L DOUBLE WALLED KETTLE



- Features:**
- Silicone insulation sleeve
 - Push button lid
 - 360° base
 - Concealed heating element
 - Integrated filter
 - Easy to clean
 - Strix thermal controller

Specification:
 Brushed Steel / Black
 0.90kg
 1000W
 0.8m cable length

Dimensions:
 Height - 158mm
 Width - 122mm
 Depth - 206mm

KENSINGTON 0.6L KETTLE



- Features:**
- Push button lid
 - 360° base
 - Removable filter
 - Strix thermal controller

Specification:
 Brushed Steel & Black
 0.70kg
 1000W
 0.7m cable length

Dimensions:
 Height - 195mm
 Width - 175mm
 Depth - 120mm

1L KETTLE (BUCKINGHAM / KTL0003)

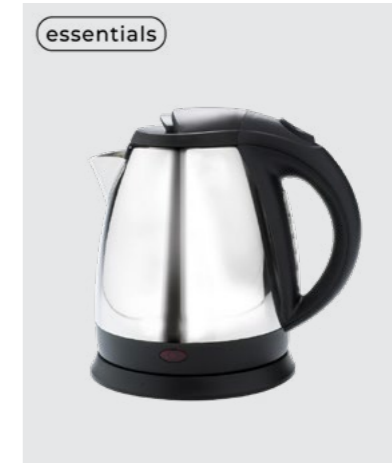

- Features:**
- 360° base
 - Concealed heating element
 - Removable filter
 - Integrated water level window
 - Strix thermal controller

Specification:
 Polished Steel & Black
 0.80kg
 1250W - 1500W
 0.7m cable length

Dimensions:
 Height - 210mm
 Width - 205mm
 Depth - 158mm

CANTERBURY 0.6L KETTLE



- Features:**
- Push button lid
 - 360° base
 - Concealed heating element
 - Integrated filter
 - Easy to clean
 - Strix thermal controller

Specification:
 Brushed Steel / Black
 0.80kg
 1000W
 0.8m cable length

Dimensions:
 Height - 158mm
 Width - 118mm
 Depth - 206mm

1L KETTLE (LANCASTER / KTL0004)

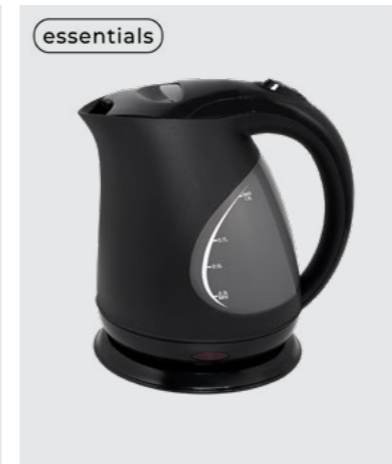

- Features:**
- 360° base
 - Concealed heating element
 - Integrated water level window
 - Removable filter
 - Strix thermal controller
 - Matt & gloss finish

Specification:
 White / Black
 0.70kg
 1200W - 1500W
 0.7m cable length

Dimensions:
 Height - 190mm
 Width - 180mm
 Depth - 143mm

CANTERBURY 1L KETTLE



- Features:**
- Push button lid
 - 360° base
 - Concealed heating element
 - Integrated filter
 - Easy to clean
 - Strix thermal controller

Specification:
 Brushed Steel / Black
 0.82kg
 1500W
 0.8m cable length

Dimensions:
 Height - 188mm
 Width - 118mm
 Depth - 206mm

0.6L DOUBLE LAYER KETTLE (SD-132)

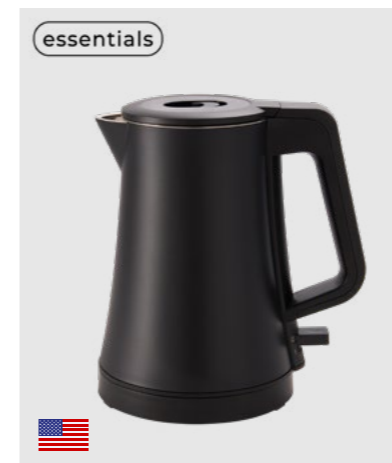

- Features:**
- Cool touch
 - Wide stable base
 - Double layer design
 - 360° base
 - Easy to clean
 - Integrated filter
 - Strix thermal controller

Specification:
 Black
 1000W
 120V
 0.76kg
 0.7m cable length

Dimensions:
 Height - 213mm
 Width - 195mm
 Depth - 143mm



ESSENTIALS LONG STAY KETTLE & TOASTER DUO

Designed specifically for longer-stay guests, the Hertford & Chelmsford duo comprises a larger-capacity kettle with a spacious toaster, providing convenient and practical appliances ideal for families. These durable, easy-to-use options enhance the comfort of extended stays by catering to everyday needs with efficiency and style.



1.8L KETTLE (HERTFORD / SD-259)



- Features:**
- Removable lid
 - Integrated filter
 - Concealed heating element
 - On/Off LED indicator switch
 - Easy to clean
 - Strix thermal controller

Specification:
 Black
 1.0kg
 1800W
 0.7m cable length

Dimensions:
 Height - 250mm
 Width - 230mm
 Depth - 150mm

2 SLICE TOASTER (CHELMSFORD / THT-8016A)

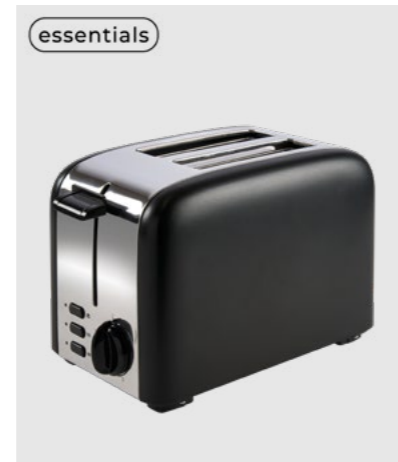

- Features:**
- Variable timing controls
 - LED indicators
 - Side out crumb tray
 - Wide slots
 - Anti-jam function

Specification:
 Black
 1.40kg
 0.75m cable length

Dimensions:
 Height - 185mm
 Width - 285mm
 Depth - 160mm

CORBY ESPRESSO MACHINE, CUPS & MUGS

For true coffee enthusiasts, the Corby Camden Espresso Machine is equipped with a high-performance Italian pump, ensuring rich, authentic barista-style coffee every time. Its sleek design pairs seamlessly with our carefully curated collection of stylish cups and mugs, enhancing the guest experience. Compact and user-friendly, the Camden is perfect for hotel rooms or lounges, offering guests café-quality coffee at their convenience.

CAMDEN ESPRESSO MACHINE



- Features:**
- Compatible with 'Nespresso Original' styled pods
 - Compact design
 - Italian pump
 - LED control buttons
 - Used capsule compartment

Specification:
 Black
 2.25kg
 1200W
 120V
 450ml water tank
 0.9m cable length

Dimensions:
 Height - 202mm
 Width - 310mm
 Depth - 83mm

SOHO ESPRESSO CUP



- Features:**
- Double walled
 - 80ml capacity
 - Easy to clean
 - Dishwasher safe up to 40°

Specification:
 Glass
 0.06kg

Dimensions:
 Height - 62mm
 Width - 65mm
 Depth - 65mm

FENTON MUG



- Features:**
- 300ml capacity
 - Easy to clean
 - Porcelain
 - Compatible with Corby drip tray
 - Dishwasher safe up to 40°

Specification:
 Black & White
 0.31kg

Dimensions:
 Height - 109mm
 Width - 118mm
 Depth - 81mm



CORBY CANTERBURY WELCOME TRAYS

Our range of Corby welcome trays features our signature drip tray, designed to eliminate the need for saucers, saving both time and money on cleaning. The Canterbury collection offers a versatile selection of trays in a variety of colours and styles, ensuring a perfect fit for any hotel room aesthetic.



CANTERBURY CLASSIC WELCOME TRAY



- Features:**
- Accommodates all Corby Canterbury kettle
 - Integrated drip tray
 - Integrated spoon tray
 - Anti-theft
 - Easy to clean

Specification:
Black
0.35kg

Dimensions:
Height - 35mm
Width - 410mm
Depth - 180mm



CANTERBURY DRAWER WELCOME TRAY



- Features:**
- Accommodates all Corby Canterbury kettles
 - Built-in drawer sachet holder
 - Integrated drip tray
 - Integrated spoon tray
 - Anti-theft
 - Easy to clean

Specification:
Black
1.02kg

Dimensions:
Height - 62mm
Width - 250mm
Depth - 210mm



CANTERBURY COMPACT WELCOME TRAYS



- Features:**
- Accommodates all Corby Canterbury kettles
 - Built-in sachet holder
 - Integrated drip tray
 - Anti-theft
 - Solid wood
 - Rubber feet

Specification:
Light Wood / Dark Wood / Black
0.60kg

Dimensions:
Height - 30mm
Width - 230mm
Depth - 226mm



CORBY KENSINGTON WELCOME TRAYS

The Corby Kensington range offers space-saving solutions designed specifically for environments where worktop space is limited. Each product features our signature drip tray design for added convenience and cleanliness.



KENSINGTON DRAWER WELCOME TRAY



- Features:**
- Accommodates the Corby Kensington 0.6L kettle
 - Built-in drawer sachet holder
 - Integrated drip tray
 - Anti-theft
 - Easy to clean

Specification:
Black
1.30kg

Dimensions:
Height - 62mm
Width - 245mm
Depth - 200mm



AINTREE WELCOME TRAY



- Features:**
- Accommodates the Corby Kensington 0.6L kettle
 - Space saving design
 - Integrated drip tray
 - Anti-theft

Specification:
Black
0.70kg

Dimensions:
Height - 31mm
Width - 230mm
Depth - 230mm



ESSENTIALS WELCOME TRAYS

This tray was designed for hoteliers who require quick and efficient replenishment. It features a separate sachet holder that can be pre-filled before room cleaning, streamlining the restocking process and saving valuable time.



WELCOME TRAY (LANCASTER / WT0022)



essentials

- Features:**
- Accommodates the Lancaster / KTL0004 kettle
 - Anti-theft
 - Integrated drip tray
 - Sachet holder sold separately

Specification:
Black
0.89kg

Dimensions:
Height - 31mm
Width - 355mm
Depth - 180mm



ESSENTIALS WELCOME TRAYS

The welcome tray range includes a variety of trays in different sizes, finishes, and materials. It also offers alternative storage options to help hotels organise guest rooms more efficiently and practically. Durable and easy to use, these trays are built to meet everyday hotel needs.



COMPACT WELCOME TRAYS (BUCKINGHAM / WT0005)

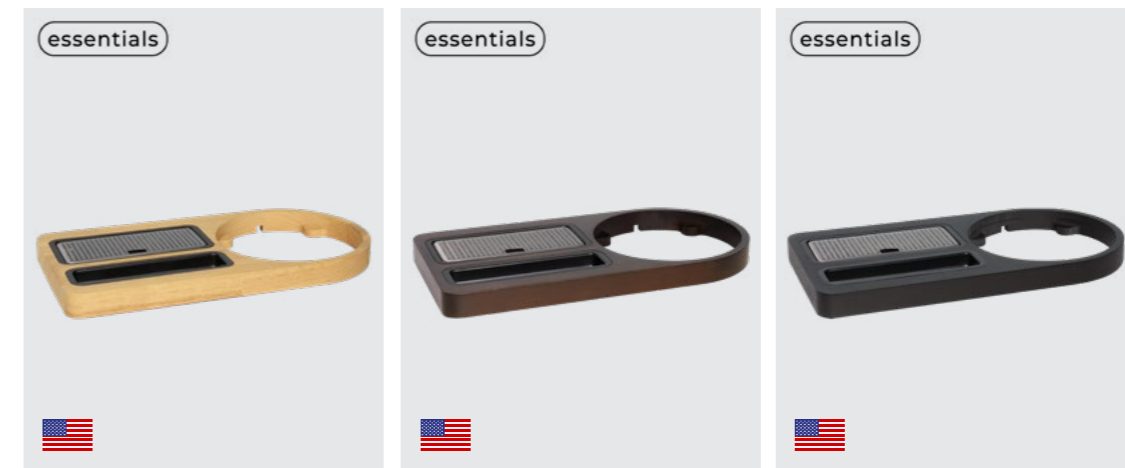

Features:

- Accommodates Buckingham / KTL0003 kettle
- Built-in sachet holder
- Integrated drip tray
- Solid wood / MR MDF
- Anti-theft

Specification:
Light Wood / Dark Wood / Black
0.67kg

Dimensions:
Height - 30mm
Width - 335mm
Depth - 180mm

STANDARD WELCOME TRAYS (BUCKINGHAM / WT0001)

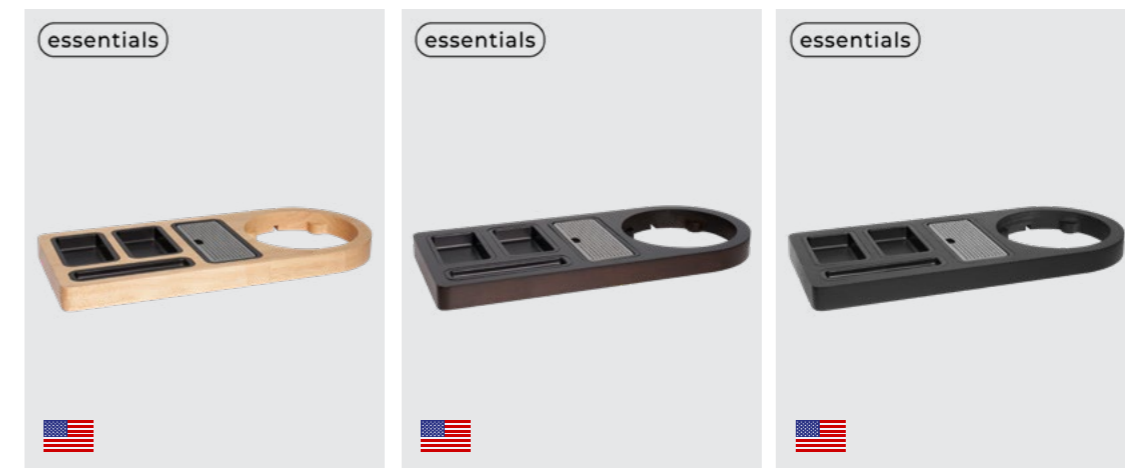

Features:

- Accommodates Buckingham / KTL0003 kettle
- Built-in sachet holder
- Integrated drip tray
- Solid wood / MR MDF
- Anti-theft

Specification:
Light Wood / Dark Wood / Black
1.40kg

Dimensions:
Height - 35mm
Width - 460mm
Depth - 200mm

WELCOME TRAY (ASCOT / WT0023)

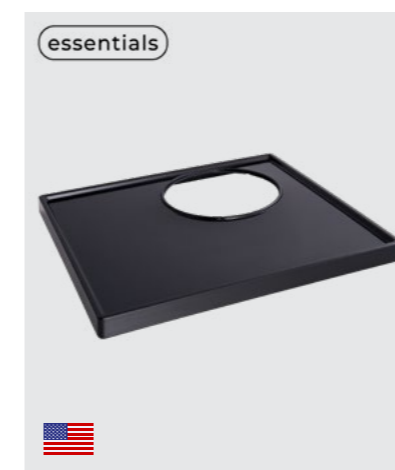

Features:

- Accommodates Buckingham / KTL0003 kettle
- Durable melamine
- Hard wearing & heat resistant up to 140°C
- Integrated kettle design
- Raised sides

Specification:
Black
0.50kg

Dimensions:
Height - 22mm
Width - 345mm
Depth - 313mm

CORBY PU LEATHER HOSPITALITY TRAYS & SACHET HOLDERS

Our collection of PU leather hospitality trays is crafted to elevate the guest experience with a sophisticated blend of style and functionality. Meticulously designed with attention to detail, each tray offers exceptional durability while adding a touch of luxury to any setting.



HIGHLAND LARGE HOSPITALITY TRAY



HIGHLAND STANDARD HOSPITALITY TRAY



HIGHLAND SACHET HOLDER



HIGHLAND COFFEE POD & SACHET HOLDER



Features:

- Accommodates all Corby kettles, espresso machine, sachet holders & mug trays
- Luxury PU leather finish
- Durable PVC construction
- Raised sides

Specification:
Black
2.68kg

Dimensions:
Height - 45mm
Width - 457mm
Depth - 407mm

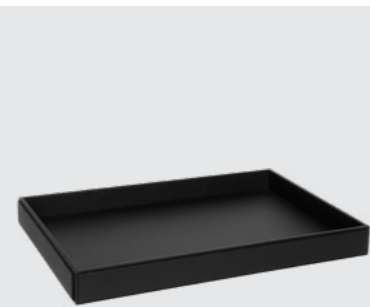

Features:

- Accommodates all Corby kettles, espresso machine, sachet holders & mug trays
- Luxury PU leather finish
- Durable PVC construction
- Raised sides

Specification:
Black
2kg

Dimensions:
Height - 45mm
Width - 403mm
Depth - 303mm



Features:

- 3 storage compartments
- Luxury PU leather finish
- Durable PVC construction

Specification:
Black
0.70kg

Dimensions:
Height - 62mm
Width - 152mm
Depth - 152mm



Features:

- 4 coffee pod compartments
- 2 storage compartments
- Luxury PU leather finish
- Durable PVC construction

Specification:
Black
0.72kg

Dimensions:
Height - 42mm
Width - 217mm
Depth - 151mm



CORBY SOLID WOOD HOSPITALITY TRAYS & SACHET HOLDERS

Expertly crafted from sustainably sourced solid wood, this collection of hospitality trays and sachet holders showcases timeless elegance, highlighted by the rich, natural texture of the wood grain, perfectly blending classic charm with refined craftsmanship.



BUXTON COMPACT HOSPITALITY TRAY

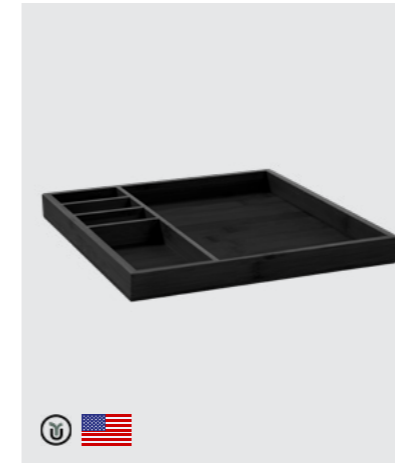

Features:

- Accommodates all Corby kettles
- Made of BUSA bamboo
- Matt wood grain finish
- Built in sachet holders
- Raised sides

Specification:
Black
0.63kg

Dimensions:
Height - 35mm
Width - 300mm
Depth - 300mm



RICHMOND COMPACT BUTLER TRAY

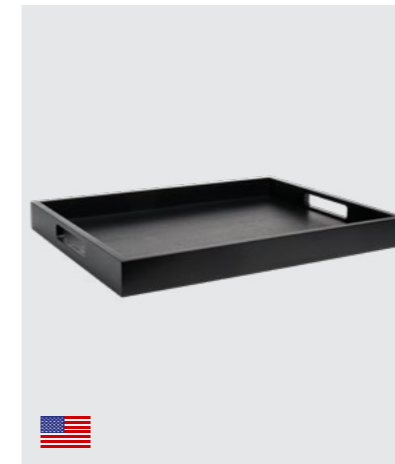

Features:

- Accommodates all Corby kettles, sachet holders and mug trays
- Solid wood construction
- Integrated handles
- Raised sides

Specification:
Black
0.85kg

Dimensions:
Height - 40mm
Width - 420mm
Depth - 320mm

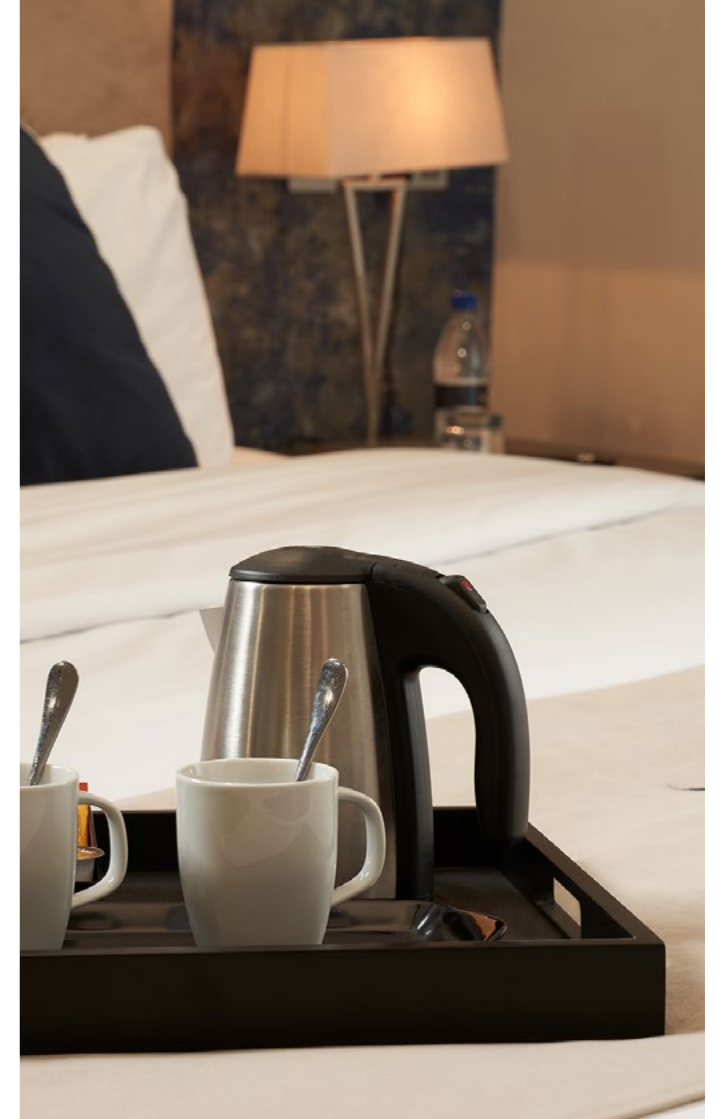

BUXTON LARGE HOSPITALITY TRAY

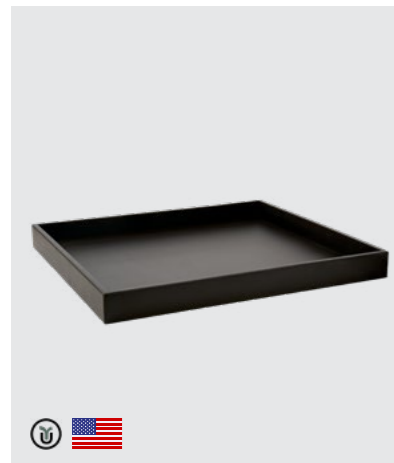

Features:

- Accommodates all Corby kettles, espresso machine, sachet holders and mug trays
- Made of BUSA bamboo
- Matt wood grain finish
- Raised sides

Specification:
Black
1kg

Dimensions:
Height - 40mm
Width - 450mm
Depth - 400mm



BUXTON STANDARD HOSPITALITY TRAY

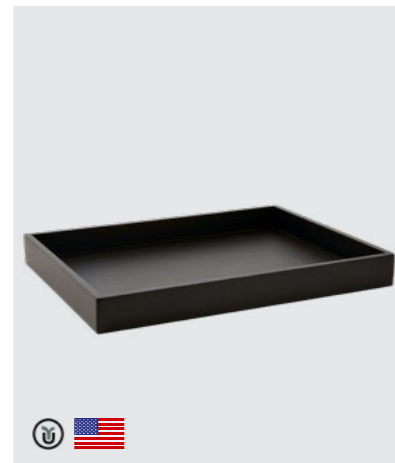

Features:

- Accommodates all Corby kettles, espresso machine, sachet holders and mug trays
- Made of BUSA bamboo
- Matt wood grain finish
- Raised sides

Specification:
Black
0.71kg

Dimensions:
Height - 40mm
Width - 400mm
Depth - 300mm



BUXTON SACHET HOLDER

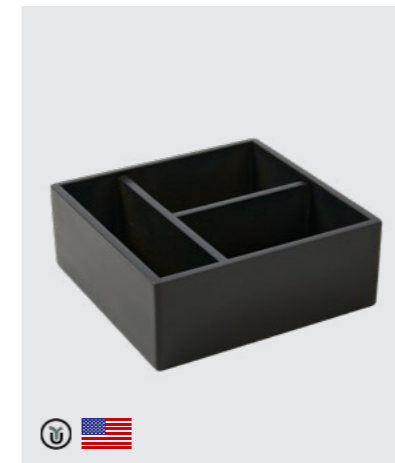

Features:

- 3 storage compartments
- Made of BUSA bamboo
- Matt wood grain finish

Specification:
Black
0.25kg

Dimensions:
Height - 60mm
Width - 145mm
Depth - 145mm



BUXTON COFFEE POD & SACHET HOLDER

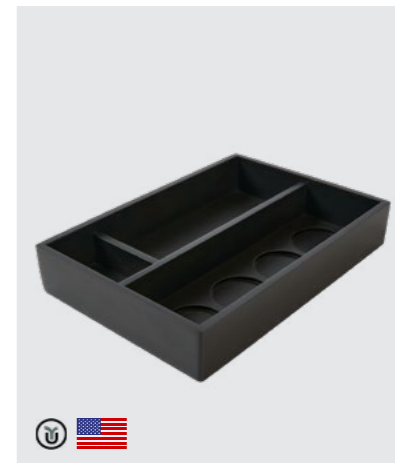

Features:

- 4 coffee pod compartments
- 2 storage compartments
- Made of BUSA bamboo
- Matt wood grain finish

Specification:
Black
0.25kg

Dimensions:
Height - 40mm
Width - 210mm
Depth - 145mm



PLASTIC HOSPITALITY TRAYS & SACHET HOLDERS

Available in a variety of finishes and styles, this collection can be effortlessly mixed and matched with a range of kettles and sachet holders to create a cohesive and stylish hospitality setup.



MUG TRAY (ASCOT / WT0012)

essentials



Features:

- Durable melamine
- Hard wearing & heat resistant up to 140°C
- Integrated handles
- Raised sides

Specification:

Black
0.20kg

Dimensions:

Height - 20mm
Width - 318mm
Depth - 128mm



SACHET HOLDER (THAME / SAC0003)

essentials



Features:

- Durable melamine
- 3 storage compartments
- Easy to clean
- Hard wearing & heat resistant up to 140°C

Specification:

Black
0.15kg

Dimensions:

Height - 45mm
Width - 150mm
Depth - 100mm



KENSINGTON SACHET HOLDER

essentials



Features:

- Durable nylon
- 4 storage compartments
- Easy to clean
- Hard wearing & heat resistant up to 140°C

Specification:

Black
0.25kg

Dimensions:

Height - 38mm
Width - 211mm
Depth - 168mm



SACHET HOLDER (ASCOT / SAC0002)

essentials



Features:

- Durable melamine
- 3 storage compartments
- Easy to clean
- Hard wearing & heat resistant up to 140°C

Specification:

Black
0.10kg

Dimensions:

Height - 40mm
Width - 95mm
Depth - 125mm



HOSPITALITY TRAY (EPSOM / WT0021)

essentials

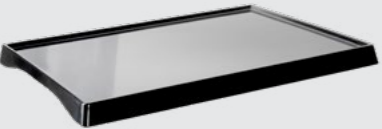

Features:

- Accommodates all Corby kettles
- Durable gloss melamine
- Hard wearing & heat resistant up to 140°C
- Easy to clean
- Raised sides

Specification:

Black
0.80kg

Dimensions:

Height - 26mm
Width - 398mm
Depth - 300mm



HOSPITALITY TRAY (WT0024)

essentials



Features:

- Accommodates all Corby kettles
- ABS
- Wood grain effect
- Raised sides & feet

Specification:

Black
0.45kg

Dimensions:

Height - 20mm
Width - 398mm
Depth - 288mm



SACHET HOLDER (MIDDLETON / SAC0001)

essentials



Features:

- ABS
- 4 storage compartments
- Rubber feet
- Easy to clean

Specification:

Black
0.10kg

Dimensions:

Height - 55mm
Width - 125mm
Depth - 75mm



SACHET HOLDER (KINGSTON / SAC0004)

essentials



Features:

- Durable melamine
- Large storage compartment
- Easy to clean
- Hard wearing & heat resistant up to 140°C

Specification:

Black
0.28kg

Dimensions:

Height - 55mm
Width - 200mm
Depth - 75mm





CORBY HAIR DRYERS

Designed for guest safety, our range of stylish & functional hair dryers are available in a variety of colours, styles and specifications. Why not comwastebaskete them with one of our hair dryer storage solutions? Designed for different applications, our holders and bags protect the hair dryer whilst being a stylish addition to the room's aesthetic.

ICONIC & IONIC

As a 90 year old brand, it's important to keep up with ever changing trends & technology. Ionic technology provides a more effective way to dry all hair types. The negative ionic charge helps retain moisture, resulting in smoother, healthier looking hair with less frizz.



Ionic Technology

Ionic technology provides a more effective way to dry all hair types.



YOU'RE IN CONTROL

With up to 2000W of hand-held power & heat, it's important that hair dryers are used correctly. Unfortunately, not all guests feel the same way, which is why Corby offer Trigger Activated solutions for hoteliers who would like that little extra peace of mind.



British Designed

Our specialized range of hotel electricals & accessories is ever-evolving alongside styles & trends we see around the world. This is why we are confident we can accommodate any guest room environment.



Trigger Activated

Specially designed for hotels, the Stratus hair dryer works on trigger activation for guest safety. The trigger activation button is easy to use and friendlier to the environment.

SLEEK STORAGE

Corby of Windsor offer a range of storage solutions that can be used for various portable hair dryers. Most Corby hair dryers feature a specially coiled cable, which makes it much easier to store than conventional hair dryers. For example the Stratus Drawer Mounted Holder is designed to uniquely store the product so it is presented like it has never been used before.



Bromley Hair Dryer Ring
Shown with Dalton 1600W hair dryer.



Clutch Hair Dryer Holder
Shown with Stratus 1875W hair dryer.



Darwen Hair Dryer Bag
Shown with the Bedford 2000W folding hair dryer. The Darwen hair dryer bag is made from a durable cotton and protects the hairdryer when not in use.



Coiled Cable

Corby coiled cable hair dryers can extend from 0.8m to 2.1m in length. This makes them easy to store when compared to conventional hair dryers.



Darwen Hair Dryer Bag

Shown with the Bedford 2000W folding hair dryer. The Darwen hair dryer bag is made from a durable cotton and protects the hairdryer when not in use.

CORBY HAIR DRYERS

Corby offers a diverse range of hair dryers, meticulously designed with adjustable power, speed, and temperature settings. Engineered to combine style and functionality, this collection caters to the needs of both hoteliers and their guests, ensuring a seamless and comfortable experience.

SKYE HAIR DRYER

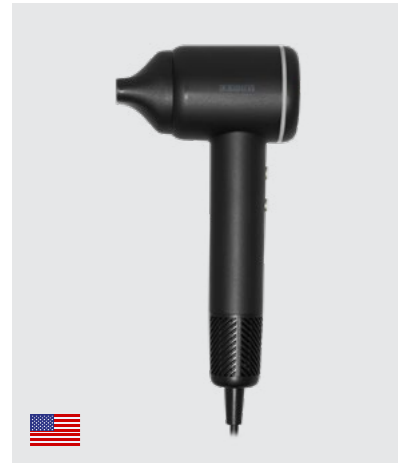

Features:

- Ionic technology
- LED light heat indicator
- 2 speed / 4 temperature settings
- Magnetic removable filter
- Straight cable
- 103,000 RPM

Specification:

Black
1600W
125V
0.50kg
78 dB
2.2m cable length

Dimensions:

Height - 280mm
Width - 130mm
Depth - 70mm



MILTON 1875W HAIR DRYER

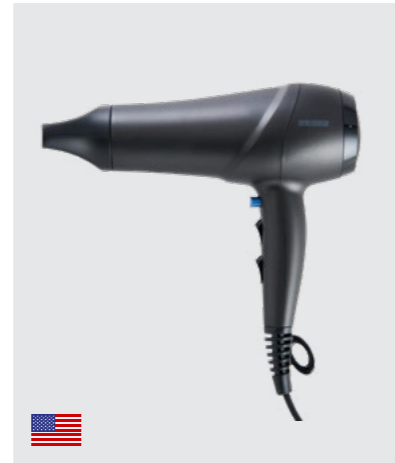

Features:

- Ionic technology
- 2 speed / 3 temperature settings
- Cool blow feature
- Coiled cable
- Removable filter
- 17,200 RPM

Specification:

Black
1875W
125V
0.60kg
80 dB
1.9m cable length

Dimensions:

Height - 265mm
Width - 270mm
Depth - 90mm



KENDAL 1600W HAIR DRYER / Wall Mounted



Features:

- Trigger activated
- Wall mounted
- 2 speed / 3 temperature settings
- Coiled cable
- Integrated filter
- 13,000 RPM

Specification:

White & Chrome
1600W
1.40kg
75 dB
Shaver socket: 0.05/230v & 0.1/115v

Dimensions:

Height - 260mm
Width - 260mm
Depth - 135mm

1200W HAIR DRYER (LINTON / RCY-67250) Wall / Drawer Mounted

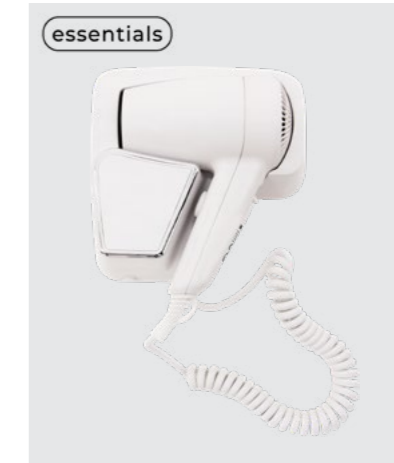

Features:

- Trigger activated
- Wall mounted
- 2 speed / 2 temperature settings
- Coiled cable
- Integrated filter
- 13,000 RPM

Specification:

White & Chrome
1200W
0.75kg
67 dB
0.8 - 2.1m cable length

Dimensions:

Height - 180mm
Width - 200mm
Depth - 95mm

2000W HAIR DRYER (BEDFORD / CH-605)

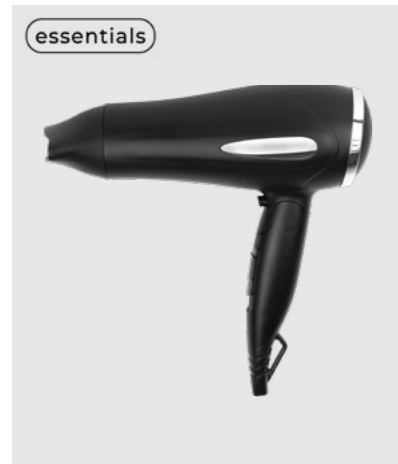

Features:

- Folding design
- 2 speed / 3 temperature settings
- Cool blow feature
- Coiled cable
- Removable filter
- 18,000 RPM

Specification:

Black & Chrome
2000W
0.60kg
76 dB
0.8 - 2.1m cable length

Dimensions:

Height - 280mm (130mm folded)
Width - 260mm
Depth - 90mm

STRATUS 1500W HAIR DRYER

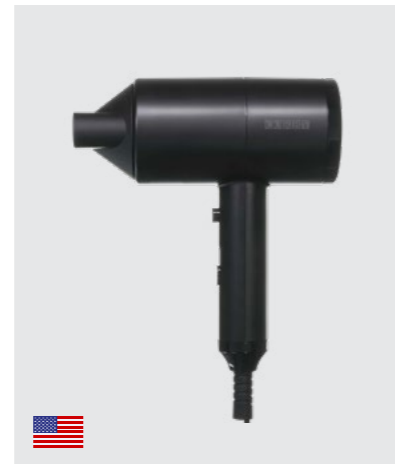

Features:

- Ionic technology
- Trigger activated
- 2 speed / 3 temperature settings
- Removable filter
- Coiled cable
- 17,000 RPM

Specification:

Black
1500W
125V
0.50kg
81 dB
1.8m cable length

Dimensions:

Height - 240mm
Width - 178mm
Depth - 73mm



1200W HAIR DRYER (LINTON / 1808-10)



Features:

- Trigger activated
- Ergonomic handle design
- 2 speed / 2 temperature settings
- Integrated filter
- Overheat protection
- 13,000 RPM

Specification:

White
1200W
0.40kg
67 dB
1.7m cable length

Dimensions:

Height - 219mm
Width - 132mm
Depth - 80mm

DALTON 1600W HAIR DRYER



Features:

- Trigger activated
- Ergonomic handle design
- 2 speed / 3 temperature settings
- Coiled cable
- Integrated filter
- 13,000 RPM

Specification:

Black & Chrome
1600W
0.50kg
75 dB
0.8 - 1.8m cable length

Dimensions:

Height - 260mm
Width - 155mm
Depth - 80mm



CORBY HAIR DRYER ACCESSORIES

We offer a variety of storage solutions for our hair dryers, catering to different hotel needs and guest preferences. For a touch of elegance, our luxurious PU leather cases provide a stylish and protective option. Alternatively, our wall-mounted holders offer a practical and space-saving solution, ensuring the hair dryer is securely stored and easily accessible.

SKYE HAIR DRYER CASE



- Features:**
- Accommodates the Skye hair dryer ONLY
 - Luxury PU leather finish
 - Velour interior finish
 - International hair dryer symbol

Specification:
Black
0.80kg

Dimensions:
Height - 125mm
Width - 350mm
Depth - 110mm



STRATUS HAIR DRYER HOLDER / *Drawer Mounted*

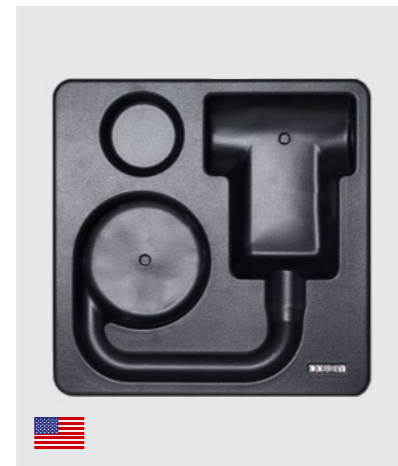

- Features:**
- Accommodates the Stratus hair dryer ONLY
 - Suitable for drawer mounting
 - Cable tidy
 - 2 fixing locations
 - Easy to clean

Specification:
Black
0.30kg

Dimensions:
Height - 325mm
Width - 325mm
Depth - 45mm



CLUTCH HAIR DRYER HOLDER

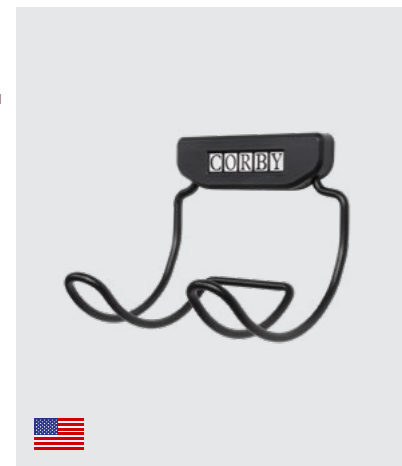

- Features:**
- Suitable for the Stratus, Milton, Bedford & Dalton hair dryers
 - Wall mounted
 - Concealed fixings
 - Rigid & durable construction

Specification:
Black
0.20kg

Dimensions:
Height - 105mm
Width - 120mm
Depth - 100mm



BROMLEY RING HAIR DRYER HOLDER



- Features:**
- Suitable for the Bedford, Milton, & Dalton hair dryers
 - Wall mounted
 - Concealed fixings
 - Rigid & durable construction

Specification:
Black
0.10kg

Dimensions:
Height - 65mm
Width - 100mm
Depth - 90mm



DURHAM HOLDER

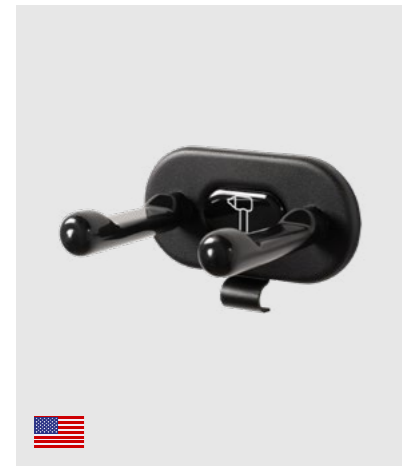

- Features:**
- Wall mounted with optional anti-theft feature
 - Durable steel construction
 - Concealed fixings with product icon
 - Anti-scratch protection
 - Compatible with all Corby hair dryers

Specification:
Black
0.29kg

Dimensions:
Height - 69mm
Width - 110mm
Depth - 81mm



DARWEN HAIR DRYER BAG

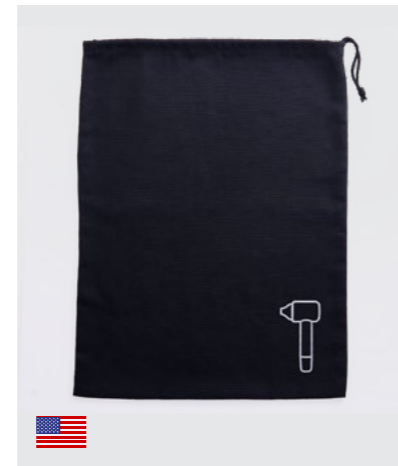

- Features:**
- Hair dryer symbol
 - Cotton storage bag
 - Drawstring closing
 - Machine washable
 - Compatible with all Corby hair dryers

Specification:
Black
0.06kg

Dimensions:
Height - 400mm
Width - 290mm
Depth - 5mm





MINIBARS 59

CORBY MINIBARS

The Eton E is the world's highest rated glass door minibar on the market.* Its innovative shelf design & use of space allow for its Silent Peltier Technology to cool it effectively, perfect for a night's stay. If your guests require a larger minibar, we offer 10L, 20L, 35L, 40L & 45L options with glass or solid lockable doors, that are sure to compliment guest room furniture. *Checked on 20/06/23

TAKE IT EASY

As a supplier for some of the world's finest hotels, Corby of Windsor understand that relaxation and functionality are key to any high-end hotel stay. The Minibar Collection was specifically designed to include silent technology and fit a variety of spaces, ensuring your guests receive a good night's rest every time.



MINIBARS 60



Peltier Silent Technology

Corby Minibars were designed to incorporate state of the art Peltier Silent Technology to ensure that guests have a restful stay.



Adjustable Cooling Technology

Corby minibars have an adjustable dial on the rear, allowing hoteliers to set the desired temperature of the contents.



THE ART OF FLEXIBILITY

Corby minibars are designed to be adaptable to open from either the left or right side, making them suitable for most guest room layouts.



Lockable Eton Door Minibar

All the solid door Eton Minibars are lockable for additional security & peace of mind for all guests.

Flexible Design

Eton solid door minibars can be fully integrated within furniture by fitting a 'minibar slider kit'. This creates a seamless look for minimalist styled interiors.

EMBRACING ELEGANCE

Embrace the best of guest room hospitality with the modern elegance of the Corby of Windsor minibar collection. Our minibars have a modern & clean aesthetic which creates a high quality hospitality experience to suit a variety of guest room spaces.



Low E Glass
Low - emissivity glass has a special coating designed to reflect heat back into the room, making Eton Minibars extra cold.

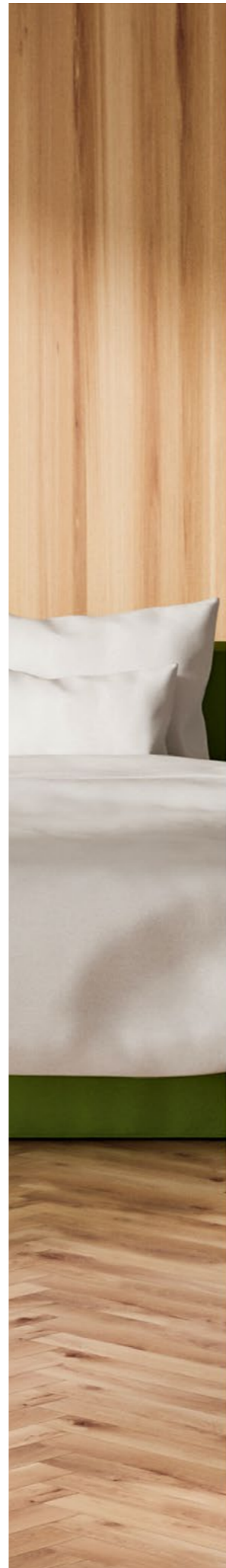

ANCIENT ART
INTERIOR DESIGN

CORBY MINIBARS

The Corby Minibar Collection offers a diverse selection of sizes and styles, each meticulously designed to seamlessly integrate into hotel guest rooms. From the sleek glass-door models to the spacious 45L drawer-style units, every minibar is engineered for silent operation and efficient cooling. Designed with precision, these minibars fit beautifully into a variety of room layouts, ensuring both functionality and aesthetic appeal.

HENLEY 1.58 cu.ft. (45L) DRAWER MINIBAR \ Solid Door



Features:

- Drawer open minibar
- Adjustable shelving systems
- Silent operation
- Interior LED light

Specification:

Black
45L
14kg
58W
110-120V
R600a Refrigerant
Insulation - Cyclopentane

Dimensions:

Height - 425mm
Width - 490mm
Depth - 460mm

Capacity Guide:



- 3 x Chocolate Bars
- 3 x Breakfast Bars
- 2 x 200g Chocolate Treat Bags
- 7 x Mini Cans
- 8 x 250ml Tall Cans
- 4 x 330ml Cans
- 3 x 330ml Bottles

- 1 x 1L Water Bottle or
- 1 x 750ml Wine bottle

ETON 1.41 cu.ft. (40L) MINIBAR \ Solid Door



Features:

- Lockable door (2 keys supplied)
- Left or right opening
- Silent operation
- Interior LED light

Specification:

Black & White
40L
11.40kg
58W
110-120V
R600a Refrigerant
Insulation - Cyclopentane
1.3m cable length

Dimensions:

Height - 560mm
Width - 400mm
Depth - 425mm

Capacity Guide:

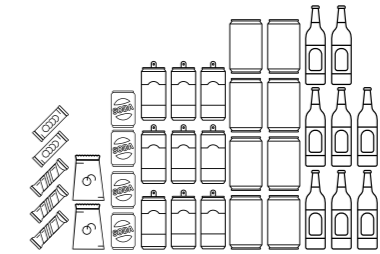

- 3 x Chocolate Bars
- 2 x Breakfast Bars
- 2 x 200g Chocolate Treat Bags
- 4 x Mini Cans
- 6 x 250ml Tall Cans
- 4 x 330ml Cans
- 7 x 330ml Bottles

RADLEY 1.41 cu.ft. (40L) MINIBAR \ Solid Door



Features:

- Retro design
- Left or right opening
- Silent operation
- Interior LED light

Specification:

Black & White
40L
12.30kg
58W
110-120V
R600a Refrigerant
Insulation - Cyclopentane
1.3m cable length

Dimensions:

Height - 560mm
Width - 400mm
Depth - 425mm

Capacity Guide:



- 3 x Chocolate Bars
- 2 x Breakfast Bars
- 2 x 200g Chocolate Treat Bags
- 4 x Mini Cans
- 6 x 250ml Tall Cans
- 4 x 330ml Cans
- 7 x 330ml Bottles

ETON 1.41 cu.ft. (40L) MINIBAR \ Glass Door



Features:

- Adjustable shelving systems
- Low E glass
- Silent operation
- Interior LED light
- Left or right opening

Specification:

Black & White / Black
40L
15.80kg
58W
220-240V ~ 50-60Hz
R600a refrigerant
Insulation - Cyclopentane

Dimensions:

Height - 570mm
Width - 400mm
Depth - 410mm

Capacity Guide:

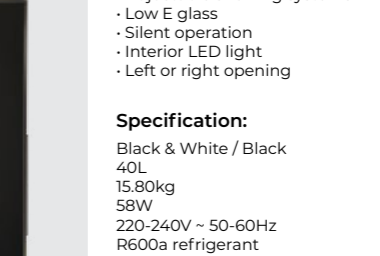

- 3 x Chocolate Bars
- 2 x Breakfast Bars
- 2 x 200g Chocolate Treat Bags
- 9 x Mini Cans
- 6 x 250ml Tall Cans
- 4 x 330ml Cans
- 3 x 330ml Bottles
- 1 x 1L Water Bottle
- 1 x 750ml Wine Bottle

RADLEY 1.41 cu.ft. (40L) MINIBAR \ Solid Door



Features:

- Retro design
- Left or right opening
- Silent operation
- Interior LED light

Specification:

Cream & White
40L
12.30kg
58W
110-120V
R600a Refrigerant
Insulation - Cyclopentane
1.3m cable length

Dimensions:

Height - 560mm
Width - 400mm
Depth - 425mm

Capacity Guide:

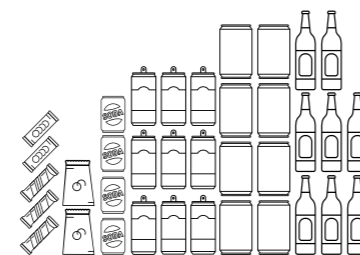

- 3 x Chocolate Bars
- 2 x Breakfast Bars
- 2 x 200g Chocolate Treat Bags
- 4 x Mini Cans
- 6 x 250ml Tall Cans
- 4 x 330ml Cans
- 7 x 330ml Bottles

ETON 1.23 cu.ft. (35L) MINIBAR \ Solid Door



Features:

- Lockable door (2 keys supplied)
- Left or right opening
- Silent operation
- Interior LED light

Specification:

Black & White
35L
58W
110-120V
10.10kg
R600a Refrigerant
Insulation - Cyclopentane

Dimensions:

Height - 475mm
Width - 385mm
Depth - 455mm

Capacity Guide:



- 3 x Chocolate Bars
- 2 x Breakfast Bars
- 6 x Mini Cans
- 6 x 250ml Tall Cans
- 3 x 330ml Bottles
- 1 x 1L Water Bottle
- 1 x 750ml Wine Bottle

ETON 1.23 cu.ft. (35L) MINIBAR | Glass Door



- Features:**
- Adjustable shelving systems
 - Low E glass
 - Silent operation
 - Left or right opening

Specification:
 Black & White / Black
 35L
 12.90kg
 58W
 R600a Refrigerant
 Insulation - Cyclopentane

Dimensions:
 Height - 485mm
 Width - 385mm
 Depth - 450mm

Capacity Guide:



- 3 x Chocolate Bars
- 2 x Breakfast Bars
- 6 x Mini Cans
- 6 x 250ml Tall Cans
- 3 x 330ml Bottles
- 1 x 1L Water Bottle
- 1 x 750ml Wine Bottle

ETON E MINIBAR | Glass Door

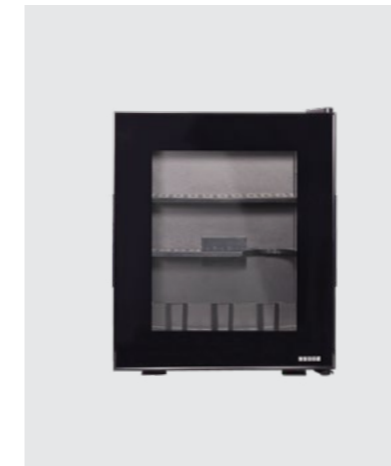

- Features:**
- B energy rating
 - Low E glass
 - Silent operation
 - Left or right opening

Specification:
 Black
 10L
 9.96kg
 58W
 R600a Refrigerant
 Insulation - Cyclopentane

Dimensions:
 Height - 440mm
 Width - 360mm
 Depth - 280mm

Energy Rating:



Capacity Guide:

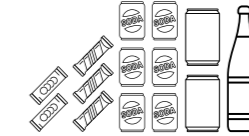

- 3 x Chocolate Bars
- 2 x Breakfast Bars
- 6 x Mini Cans
- 2 x 330ml Cans
- 1 x 1L Water Bottle

ETON 0.70 cu.ft. (20L) MINIBAR | Solid Door



- Features:**
- Lockable door (2 keys supplied)
 - Left or right opening
 - Silent operation
 - Interior LED light

Specification:
 Black & White
 20L
 8.60kg
 58W
 110-120V
 R600a Refrigerant
 Insulation - Cyclopentane
 1.3m cable length

Dimensions:
 Height - 430mm
 Width - 360mm
 Depth - 390mm

Capacity Guide:

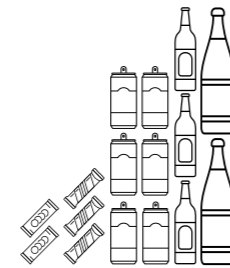

- 3 x Chocolate Bars
- 2 x Breakfast Bars
- 6 x 250ml Tall Cans
- 3 x 330ml Bottles
- 2 x 1L Water Bottle

MINIBAR SLIDER KIT



- Features:**
- Enables minibar integration into guestroom wastebaskets
 - Suitable for all Eton solid door minibars

Specification:
 Black
 0.32kg

Dimensions:
 Height - 45mm
 Width - 247mm
 Depth - 9mm



ETON 0.70 cu.ft. (20L) MINIBAR | Glass Door



- Features:**
- Adjustable shelving systems
 - Low E glass
 - Silent operation
 - Left or right opening

Specification:
 Black & White / Black
 20L
 11.70kg
 58W
 R600a Refrigerant
 Insulation - Cyclopentane

Dimensions:
 Height - 440mm
 Width - 360mm
 Depth - 385mm

Capacity Guide:

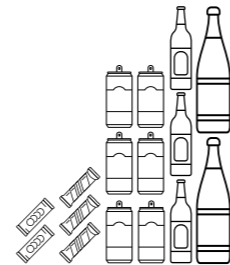

- 3 x Chocolate Bars
- 2 x Breakfast Bars
- 6 x 250ml Tall Cans
- 3 x 330ml Bottles
- 2 x 1L Water Bottle



SAFE & SOUND

As a supplier to some of the world's finest hotels, Corby of Windsor understands that relaxation and peace of mind are integral to any hotel stay. Our Corby Safes are specifically designed to fit a variety of spaces and are constructed with heavy duty steel doors.



CORBY SAFES

Safe & robust, our range of safes are designed to be secure & easy to use around the world. We offer different levels of security to make hotels & hotel guests feel at ease that their belongings are safe. Our CEU device allows hoteliers to set passcodes, change lighting and digitally record up to 125 passcodes, in the unlikely event of theft.



Touch Tone

All Corby safes are digitally controlled with touch tone display panels, making it very convenient for hotel guests to store their valuables.

PEACE OF MIND

The Corby Safes Collection is designed & engineered to be secure & easy to use around the world. We offer different levels of security to make hoteliers & hotel guests feel at ease that their belongings are safe. All safes are fitted with 18mm electronically motorised locking bolts.



Automatic Locking System

Each safe is fitted with heavy duty motorised locking bolts that can only be opened with a pass code or a unique over-ride key (supplied).



CEU (Computer Emergency Unit)

Our CEU device allows hoteliers to set passcodes, change lighting & digitally record up to 125 pass codes, in the unlikely event of theft.

CORBY SAFES & CEU

The Corby Safes Collection offers a variety of sizes and styles, each meticulously designed to seamlessly integrate into hotel guest rooms. Every safe undergoes rigorous testing for functionality and quality, ensuring both security and ease of use for guests. Crafted with precision, these safes fit beautifully into diverse hotel environments, comwastebasketing practicality with aesthetic appeal.

WESTMINSTER DIGITAL 17" LAPTOP SAFE



- Features:**
- Suitable for laptops up to 17"
 - Digital braille control panel
 - Supplied with key & batteries
 - Spring assisted door
 - Compatible with CEU

Specification:
 Black
 11.80kg
 4 x AA Batteries
 4mm steel door
 1.5mm steel body

Dimensions:
 Height - 190mm
 Width - 500mm
 Depth - 380mm



WESTMINSTER DIGITAL 15" LAPTOP SAFE



- Features:**
- Suitable for laptops up to 15"
 - Digital braille control panel
 - Supplied with key & batteries
 - Spring assisted door
 - Compatible with CEU

Specification:
 Black
 10.50kg
 25L
 4 x AA Batteries
 4mm steel door
 1.5mm steel body

Dimensions:
 Height - 195mm
 Width - 430mm
 Depth - 370mm



MAYFAIR DIGITAL OPEN TOP SAFE

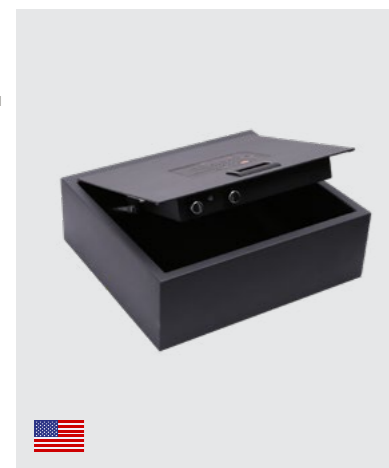

- Features:**
- Suitable for laptops up to 15"
 - Digital braille control panel
 - Supplied with key & batteries
 - Spring assisted door
 - Compatible with CEU

Specification:
 Black
 10kg
 11L
 4 x AA Batteries
 3mm steel door
 1.5mm steel body

Dimensions:
 Height - 130mm
 Width - 400mm
 Depth - 350mm



CEU / Computer Emergency Unit



- Features:**
- Holds 125 passcodes
 - Cable for CEU to computer included in pack
 - Supplied with batteries
 - Compatible with the Westminster & Mayfair Safes

Specification:
 Black
 0.30kg
 4 x AAA Batteries

Dimensions:
 Height - 28mm
 Width - 180mm
 Depth - 78mm



DIGITAL COMPACT SAFE (WHITEHALL / SFE0004)



essentials

- Features:**
- Suitable for laptops up to 14"
 - Supplied with key & batteries
 - Spring assisted door

Specification:
 Black
 9kg
 18L
 4 x AA Batteries
 4mm steel door
 1.5mm steel body

Dimensions:
 Height - 190mm
 Width - 420mm
 Depth - 300mm





CORBY BEDROOM COLLECTION

Our complimentary range has been specially selected to complete the room. These include tissue box holders, double layer wastebaskets, solid wood luggage racks and many more guestroom products.

MIX & MATCH

Our solid wood range includes welcome trays, clothes hangers and luggage racks. These have been colour matched so you can be assured that the colour and finish is consistent throughout the room.

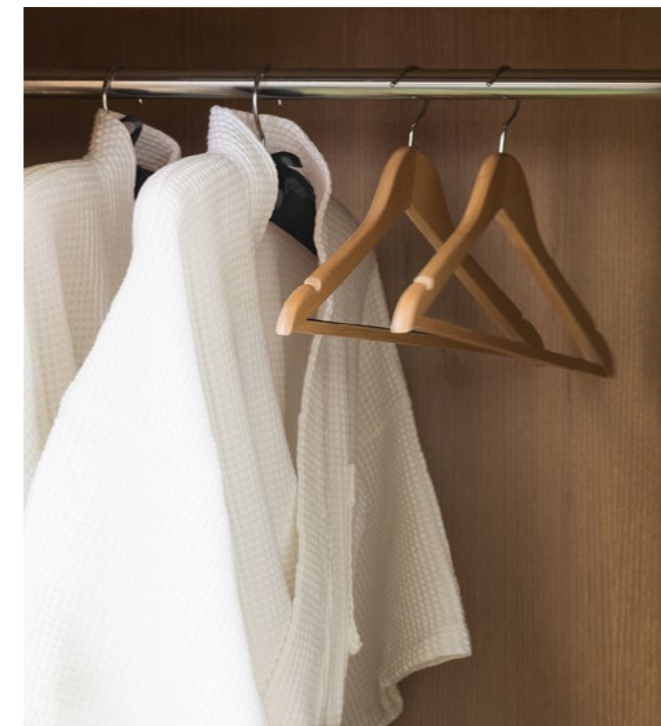

Guest Hangers

Solid wood hangers are available in hooked or security pin options in three different colours.



Light Wood



Dark Wood



Black

Luggage Racks

Constructed from solid wood, our collection of luggage racks have been tested to hold weight up to 50kg. The chrome inlays and durable nylon straps provide protection and enable them to be stored away.



Light Wood



Dark Wood



Black

MAKING RECYCLING EASY

With 28 waste management solutions, hoteliers can choose how they wish to recycle. The unique Thornton recycle wastebasket inserts can be used independently or as a set, with or without a bag liner. They feature printed international icons on top to illustrate to guests what items can be placed inside.

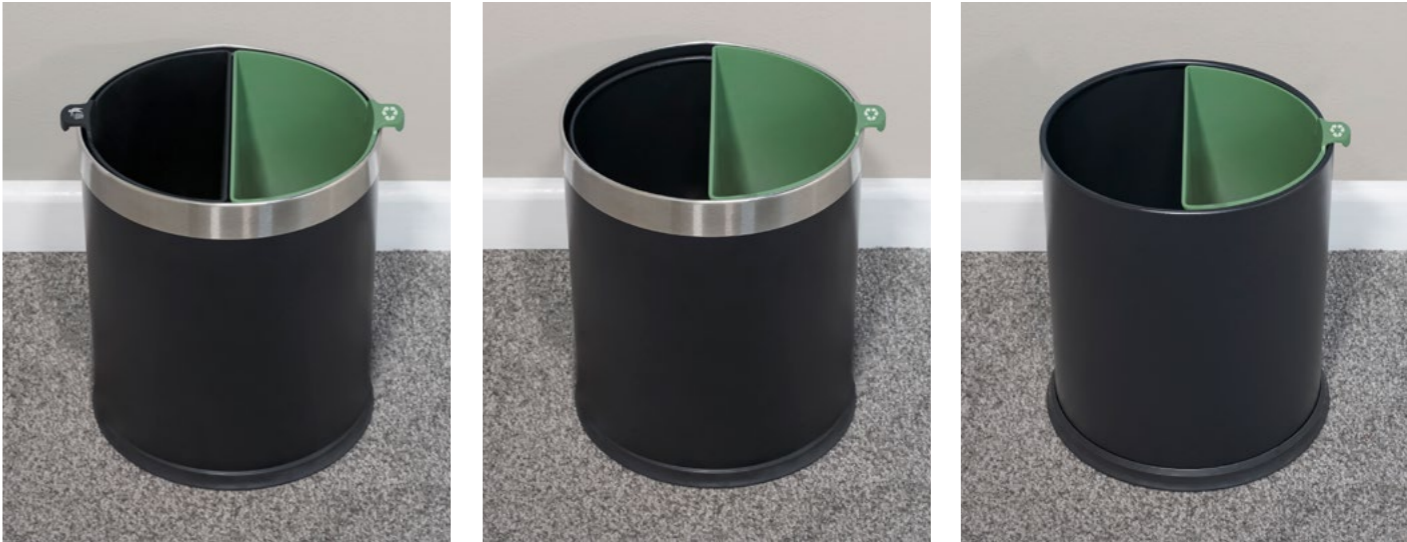

Bedroom Wastebasket Recycling

Designed to be used with our single or double layer wastebaskets, the new recycling wastebasket inserts have been cleverly designed to be used independently or as a pair. The unique handle displays internationally recognised icons for 'general waste' and 'recycling', making it easy to understand in any guest room around the world. The handle has also been designed with 2 slots that allow a wastebasket bag to be maneuvered around the handle so the icon isn't covered.

CORBY BEDROOM WASTEBASKETS

Our curated selection of wastebaskets is thoughtfully chosen with the hotel guest in mind, seamlessly blending functionality and style. This collection now features innovative recycling solutions, including the Corby Newport Dual Recycling Wastebasket and the Corby Thornton Wastebasket Insert, designed to enhance waste management while complementing contemporary hotel interiors.

HIGHLAND DUAL RECYCLING WASTEBASKET

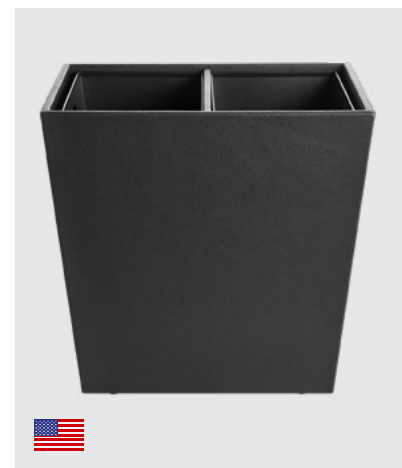

- Features:**
- Luxury PU leather finish
 - Metal inserts with handles
 - Supplied with international recycle stickers
 - Durable construction
 - Raised plastic feet

Specification:
Black
3.85kg
6L + 6L

Dimensions:
Height - 290mm
Width - 302mm
Depth - 173mm



HIGHLAND 9L DOUBLE LAYER WASTEBASKET



- Features:**
- Dual layer wastebasket
 - Steel collar
 - Luxury PU leather finish
 - Durable construction
 - Rubber base

Specification:
Black
1.36kg

Dimensions:
Height - 260mm
Width - 230mm
Depth - 230mm



DOUBLE LAYER WASTEBASKET (Wastebasket0014)



essentials

- Features:**
- Dual layer wastebasket
 - Steel outer layer
 - Recycled PP plastic inner
 - Polished steel collar

Specification:
Black & Polished Steel
0.84kg

Dimensions:
Height - 257mm
Width - 230mm
Depth - 230mm



NEWPORT DUAL RECYCLING WASTEBASKET



- Features:**
- International recycling icons
 - Removable collar and inserts
 - Durable construction

Specification:
Brushed Steel, Green & Black/
Black, Green & Black
1.96kg
6L + 6L

Dimensions:
Height - 365mm
Width - 192mm
Depth - 272mm



THORNTON 9L SINGLE LAYER WASTEBASKET



- Features:**
- Single layer wastebasket
 - Durable construction
 - Rubber base

Specification:
Brushed Steel / Black / White
0.70kg

Dimensions:
Height - 260mm
Width - 230mm
Depth - 230mm



THORNTON 9L DOUBLE LAYER WASTEBASKET



- Features:**
- Dual layer wastebasket
 - Steel collar
 - Flame retardant
 - Durable construction
 - Rubber base

Specification:
Brushed Steel / Black
1.30kg

Dimensions:
Height - 260mm
Width - 230mm
Depth - 230mm



THORNTON WASTEBASKET INSERT



- Features:**
- Printed sorting guide
 - Suitable for Corby single or double layer wastebaskets
 - Designed to be used with or without bags
 - Easy to clean

Specification:
Black (General) / Green (Recycling)
0.20kg

Dimensions:
Height - 250mm
Width - 205mm
Depth - 120mm



CORBY BEDROOM HANGERS

The Guest Hanger Collection includes solid wood and metal hangers in multiple styles and colours, along with our satin hanger available in two elegant colours. These durable and stylish hangers are designed to keep your garments organised and beautifully displayed.

CLIFFORD SUIT HANGER

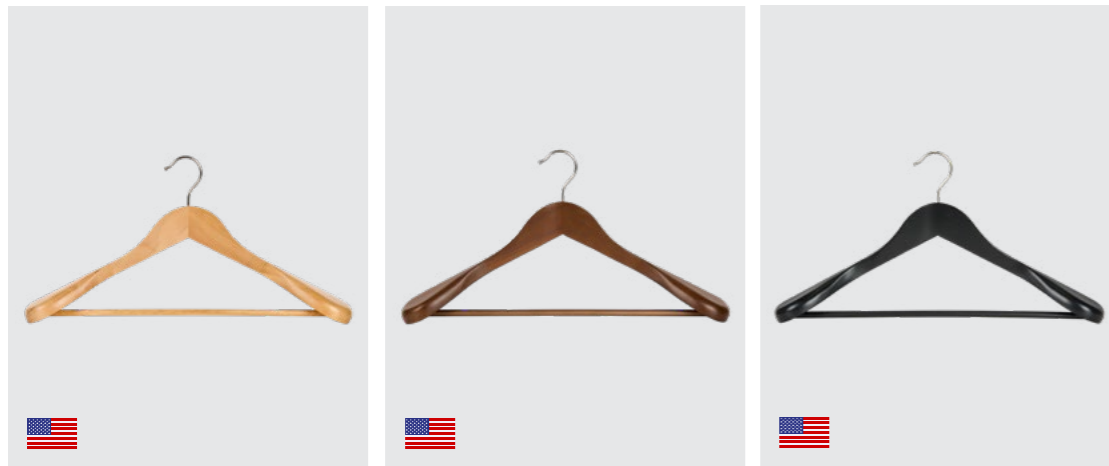

Features:

- Solid wood
- Standard hook
- Broad ends
- Trousers bar

Specification:
Light Wood / Dark Wood / Black
0.23kg

Dimensions:
Height - 227mm
Width - 450mm
Depth - 60mm

SALTAIRE SATIN GUEST HANGER



Features:

- Luxury satin finish
- Standard hook
- Bow detail
- Garment buttons

Specification:
Black / Champagne
0.06kg

Dimensions:
Height - 145mm
Width - 383mm
Depth - 40mm

BURLINGTON GUEST HANGER WITH CLIPS

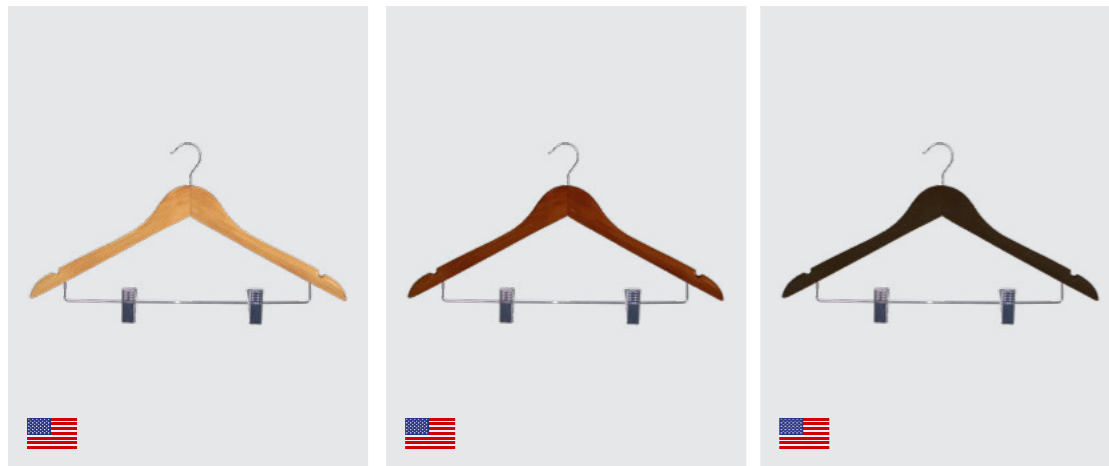

Features:

- Solid wood
- Standard hook
- Garment clips
- Garment hooks

Specification:
Light Wood / Dark Wood / Black
0.14kg

Dimensions:
Height - 265mm
Width - 445mm
Depth - 27mm

Pin options available

METAL GUEST HANGER (HGR-0007)

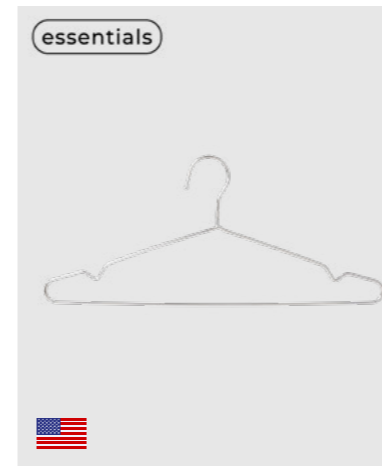

Features:

- Stainless steel
- Standard hook
- Garment hooks
- Trousers bar

Specification:
Polished Steel
0.06kg
304 grade steel

Dimensions:
Height - 186mm
Width - 420mm
Depth - 3mm

HANGER SECURITY PIN RING

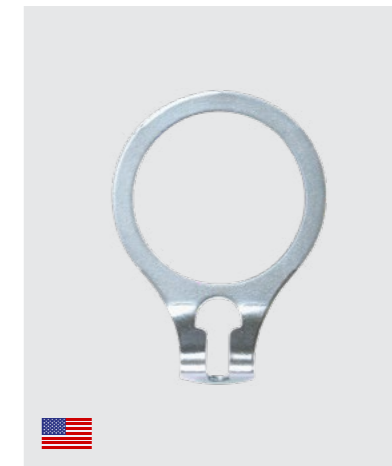

Features:

- Compatible with Corby security pin guest hangers
- Durable material

Specification:
Silver metal
0.01kg

Dimensions:
Height - 65mm
Width - 50mm
Depth - 10mm

CHELSEA GUEST HANGER

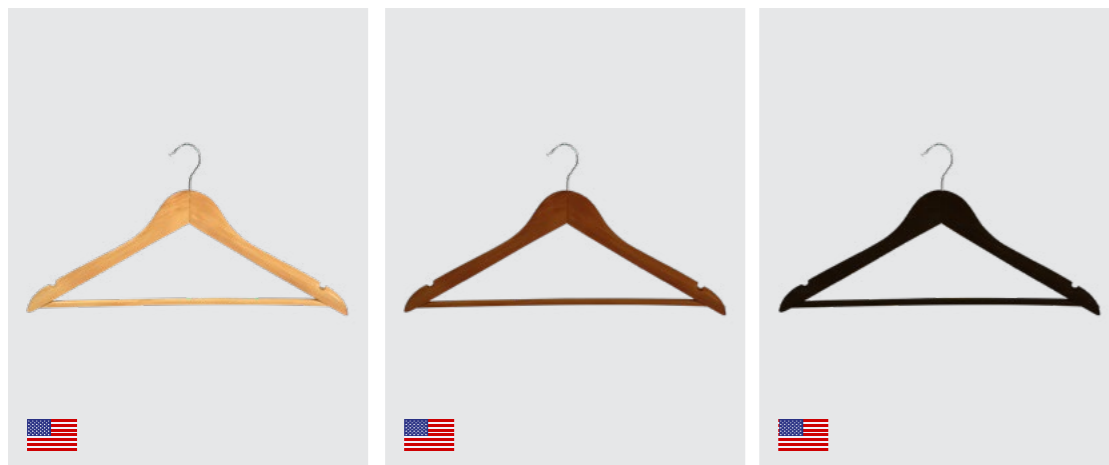

Features:

- Solid wood
- Standard hook
- Garment hooks
- Trousers bar

Specification:
Light wood / Dark Wood / Black
0.10kg

Dimensions:
Height - 215mm
Width - 445mm
Depth - 12mm

Pin options available



CORBY LUGGAGE RACKS

Crafted from solid wood or metal, our luggage racks are engineered to support up to 110.23lbs, ensuring durability and reliability. The sturdy nylon straps provide secure support for luggage, while the foldable design allows for easy storage, making them ideal for hotel guest rooms where space is at a premium.

YORK LUGGAGE RACK



Features:

- Durable nylon straps
- Chrome inlays
- Solid wood construction
- Foldable & easy to store
- Holds up to 110.23lbs

Specification:

Light Wood / Dark Wood / Black
3.49kg

Dimensions:

| | |
|----------------|----------------|
| (Open) | (Folded) |
| Height - 485mm | Height - 600mm |
| Width - 655mm | Width - 655mm |
| Depth - 385mm | Depth - 150mm |

BUXTON LUGGAGE RACK



Features:

- Made of BUSA bamboo
- Durable nylon straps
- Matt wood grain finish
- Designed to store in a wardrobe
- Holds up to 50KG

Specification:

Black
2.80kg

Dimensions:

| | |
|----------------|----------------|
| (Open) | (Folded) |
| Height - 460mm | Height - 585mm |
| Width - 450mm | Width - 450mm |
| Depth - 405mm | Depth - 120mm |



LUGGAGE RACK WITH BACK (ASHTON / LGR0001)

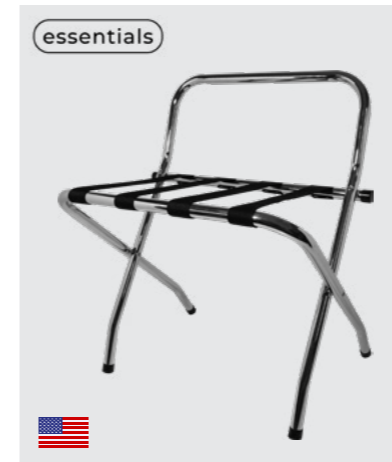

Features:

- Tubular steel construction
- Durable finish
- Durable nylon straps
- Foldable & easy to store
- Holds up to 110.23lbs

Specification:

Polished Steel & Black / Black
2.36kg

Dimensions:

| | |
|----------------|----------------|
| (Open) | (Folded) |
| Height - 680mm | Height - 865mm |
| Width - 620mm | Width - 620mm |
| Depth - 515mm | Depth - 75mm |

LUGGAGE RACK WITHOUT BACK (ASHTON / LGR0002)

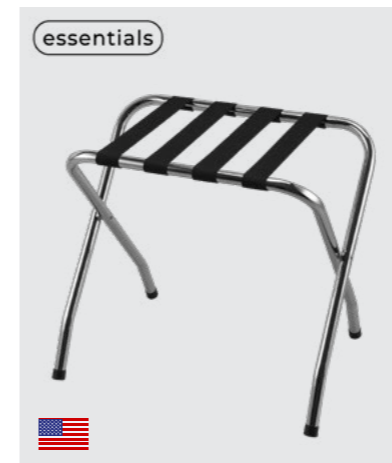

Features:

- Tubular steel construction
- Durable finish
- Durable nylon straps
- Foldable & easy to store
- Holds up to 110.23lbs

Specification:

Polished Steel & Black / Black
1.90kg

Dimensions:

| | |
|----------------|----------------|
| (Open) | (Folded) |
| Height - 480mm | Height - 630mm |
| Width - 620mm | Width - 620mm |
| Depth - 440mm | Depth - 55mm |

CORBY BEDROOM ITEMS

As part of our extended range, we offer a selection of quality hotel products designed to enhance the guest experience. Our tissue boxes come in a variety of materials and finishes, including elegant PU leather, durable resin, and natural wood, each crafted to complement your room's décor. Additionally, our guest room electricals, such as the Regent Alarm Clock and Tower Fan, comwastebasket functionality with style, ensuring both convenience and comfort for your guests.

BUXTON CUBE TISSUE BOX HOLDER



Features:

- Made of BUSA bamboo
- Matt wood grain finish
- Suitable for bathrooms and bedrooms

Specification:
Black
0.54kg

Dimensions:
Height - 146mm
Width - 142mm
Depth - 142mm



BUXTON RECTANGULAR TISSUE BOX HOLDER



Features:

- Made of BUSA bamboo
- Matt wood grain finish
- Suitable for bathrooms and bedrooms

Specification:
Black
0.54kg

Dimensions:
Height - 70mm
Width - 258mm
Depth - 142mm



RECTANGULAR TISSUE BOX HOLDER (DEVON / TBC0002)

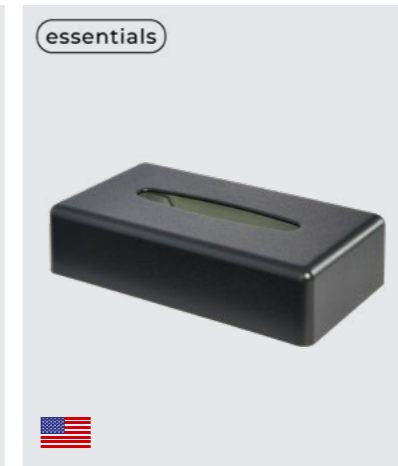

Features:

- ABS
- Detachable base
- Wall or surface mounted

Specification:
Chrome / Black
0.35kg

Dimensions:
Height - 60mm
Width - 255mm
Depth - 140mm

HIGHLAND CUBE TISSUE BOX HOLDER



Features:

- Luxury PU leather finish
- Magnetic base
- Suitable for bathrooms and bedrooms
- Durable PVC construction

Specification:
Black
1.20kg

Dimensions:
Height - 155mm
Width - 137mm
Depth - 137mm

HIGHLAND RECTANGULAR TISSUE BOX HOLDER



Features:

- Luxury PU leather finish
- Magnetic base
- Suitable for bathrooms and bedrooms
- Durable PVC construction

Specification:
Black
1.18kg

Dimensions:
Height - 74mm
Width - 246mm
Depth - 137mm

CUBE TISSUE BOX HOLDER (DEVON / TBC0001)

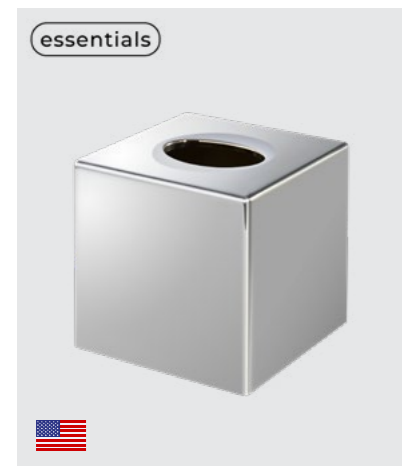

Features:

- ABS
- Detachable base
- Easy to clean

Specification:
Chrome / Black
0.30kg

Dimensions:
Height - 130mm
Width - 135mm
Depth - 135mm



REGENT ALARM CLOCK

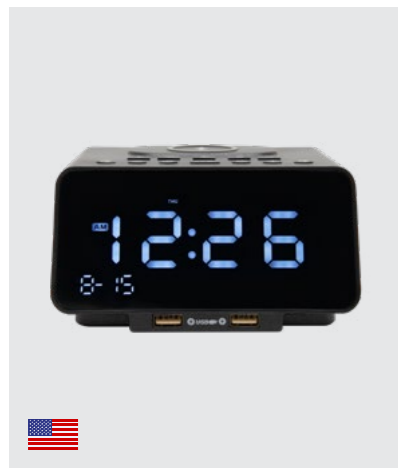

Features:

- Wireless charging
- 12/24 hour
- Digital display
- 2x USB A ports & 1x USB C port
- 2x 5W speakers
- Bluetooth

Specification:

Black
0.50kg
110-240V
0.6A
>65dB
1.2m cable length

Dimensions:

Height - 70mm
Width - 135mm
Depth - 125mm



TOWER FAN



Features:

- 70° rotation
- Manual controls
- Compact design
- 3 speed settings
- Floor standing
- 29"

Specification:

Black
50W
110-120V
2.60kg

Dimensions:

Height - 740mm
Width - 260mm
Depth - 260mm

BRIGHTON LED TORCH

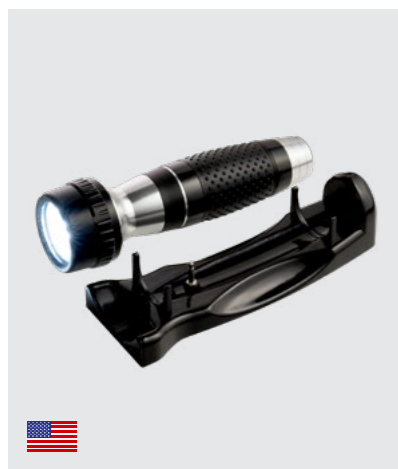

Features:

- Solid aluminium construction
- Battery powered
- Ergonomic design
- Anti-theft
- LED torch light
- Wall mountable

Specification:

Black & Chrome
3 x AA batteries
0.35kg

Dimensions:

Height - 59mm
Width - 192mm
Depth - 60mm



NORTHAMPTON SHOE HORN



Features:

- Real wood handle
- Hanging loop
- Durable material

Specification:

Black
0.08kg

Dimensions:

Height - 382mm
Width - 37mm
Depth - 11mm



SKIPTON CLOTHES BRUSH

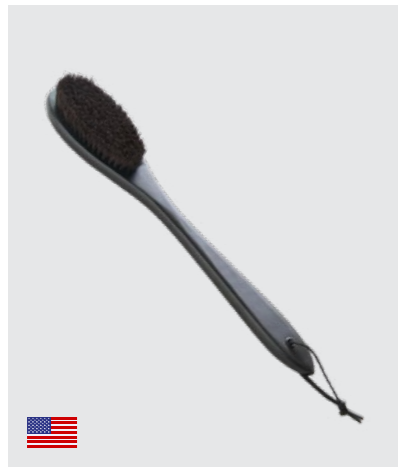

Features:

- 100% horse hair bristles
- Real wood handle
- Hanging loop
- Durable material

Specification:

Black
0.14kg

Dimensions:

Height - 376mm
Width - 60mm
Depth - 36mm



FAIRFIELD LAUNDRY BAG



Features:

- 100% cotton
- Adjustable drawstring
- Machine washable
- International laundry icon

Specification:

Natural
0.16kg

Dimensions:

Height - 550mm
Width - 450mm
Depth - 11mm





CORBY BATHROOM COLLECTION

Our bathroom items include a variety of mirrors, digital scales, and essential hygiene products to enhance functionality and ensure cleanliness in the guest bathroom. Elevate your hotel bathrooms with our thoughtfully designed products, which provide both comfort and sophistication for every guest.

RELAX & UNWIND



Sandwell Battery-Free Scales

Our glass scales are battery-free and promote an eco-friendly lifestyle. They feature a stylish glass surface and a modern design, enhancing the aesthetic of any space. These scales provide accurate weight measurements without contributing to electronic waste. Lightweight and easy to use, they support your health while being environmentally friendly.

Winchester Mirrors

The elegant Winchester Mirror range includes eight mirrors available in two classic colour options. Each mirror boasts a double-sided design with 5x magnification, making it ideal for precise grooming. The adjustable head allows for versatile positioning, making it a perfect choice for hoteliers seeking both style and practicality.



CLEAN & SIMPLE

Introducing our stylish and convenient bathroom products. The Sana Toilet Brush features an easy to clean silicone head and can be wall-mounted to keep floors tidy. The Croft 3L Bathroom Step Can, is perfect for hotel rooms, allowing guests to dispose of waste hygienically with its foot pedal.



Croft 3L Step Can

The Croft 3L bathroom step can is an essential addition to any hotel room, designed in three classic colours to enhance the guest experience while ensuring cleanliness and convenience. These wastebaskets feature a foot-operated pedal that allows guests to dispose of waste without touching the lid, promoting a more hygienic environment.



Sana Toilet Brush

The flexible silicone head has been designed to get to those hard to reach areas. The tiny bristles have been developed to be anti-drip and anti-clog, making cleaning the toilet less unpleasant.



CORBY BATHROOM ITEMS

The Corby Bathroom Items Collection offers mirrors, digital scales, bathroom fixtures and essential hygiene products that enhance the guest bathroom experience. Designed for both style and functionality, it creates a clean, comfortable, and sophisticated environment for every guest.

WINCHESTER MIRROR / FREE STANDING



- Features:**
- Double sided mirror
 - 360° rotation & tilt feature
 - Extendable arm (Chrome only)
 - 1x & 5x magnification

Specification:
Chrome / Matt Black
0.95kg

Dimensions:
Height - 340 - 420mm
Width - 230mm
Depth - 150mm

WINCHESTER LED MIRROR / WALL MOUNTED

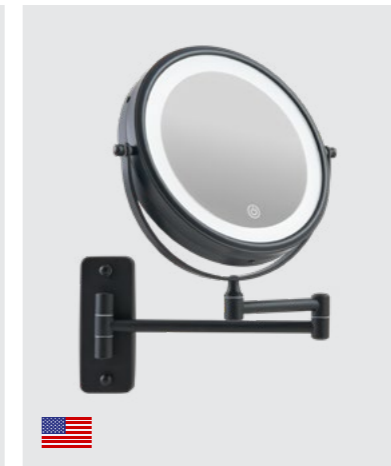
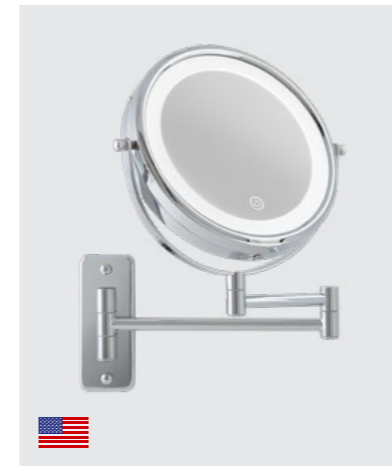

- Features:**
- LED illuminated
 - Double sided mirror
 - Auto cut-off
 - Touch screen button
 - Durable nylon hinge
 - 1x & 5x magnification
 - 360 rotation & tilt feature
 - Supplied with batteries

Specification:
Chrome / Matt Black
4 x AAA batteries
0.95kg

Dimensions:
Height - 320mm
Width - 255 - 435mm
Depth - 125mm

WINCHESTER LED MIRROR / FREE STANDING



- Features:**
- LED illuminated
 - Double sided mirror
 - Auto cut-off
 - 360° rotation & tilt feature
 - Touch screen button
 - Extendable arm (Chrome only)
 - 1x & 5x magnification
 - Supplied with batteries

Specification:
Chrome / Matt Black
4 x AAA batteries
1.10kg

Dimensions:
Height - 340 - 420mm
Width - 230mm
Depth - 150mm

HELMSLEY DIGITAL BATHROOM SCALES

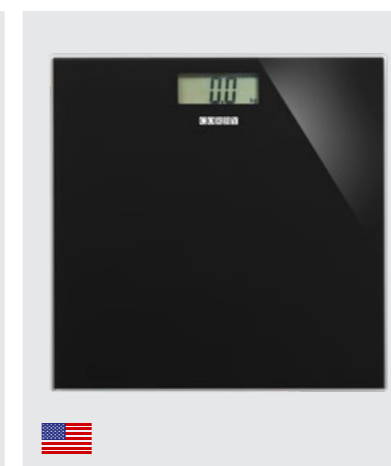
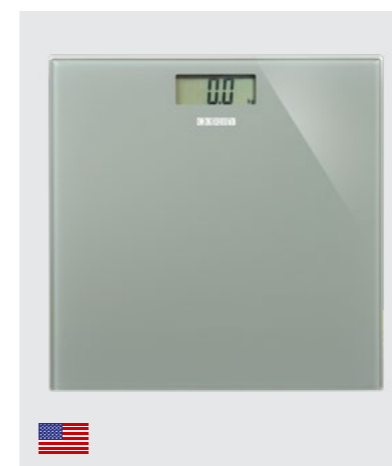

- Features:**
- LCD digital display
 - Tempered glass
 - Slimline design
 - Anti-slip rubber feet
 - Imperial & metric weight settings

Specification:
Grey / Black
1.50kg
2 x AAA batteries
6mm glass

Dimensions:
Height - 302mm
Width - 302mm
Depth - 22mm

WINCHESTER MIRROR / WALL MOUNTED

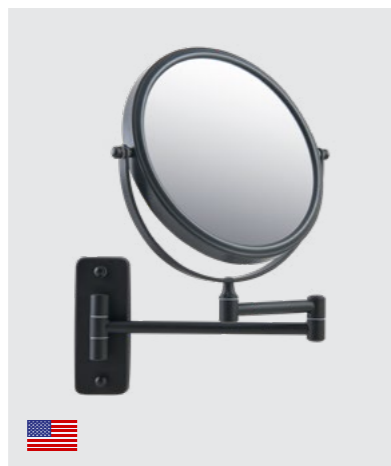

- Features:**
- Double arm mirror design
 - Double sided mirror
 - Durable nylon hinge
 - 1x & 5x magnification
 - 360 rotation & tilt feature

Specification:
Chrome / Matt Black
0.80kg

Dimensions:
Height - 320mm
Width - 255 - 435mm
Depth - 125mm

SANDWELL BATTERY-FREE SCALES



- Features:**
- Battery-free
 - Tempered glass
 - LCD digital display
 - Anti-slip rubber feet
 - Imperial & metric weight settings

Specification:
White & Clear Glass
1.30kg
6mm glass

Dimensions:
Height - 300mm
Width - 310mm
Depth - 45mm

MARSDEN BATTERY-FREE SCALES



- Features:**
- Battery-free
 - Tempered glass
 - LCD digital display
 - Anti-slip rubber feet
 - Imperial & metric weight settings

Specification:
White Glass
1.53g
6mm glass

Dimensions:
Height - 308mm
Width - 308mm
Depth - 33mm



BATH MAT (DOVER / SPA0006)

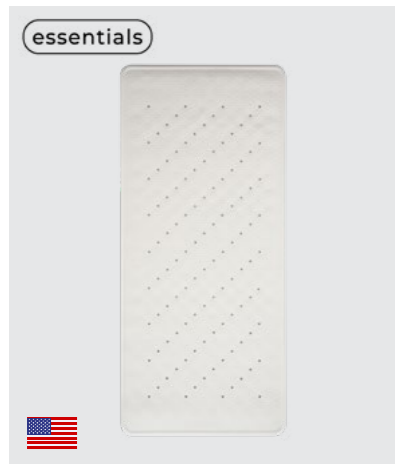

Features:

- Easy to clean
- Textured rubber
- Anti-slip suction pads

Specification:

White
0.77kg

Dimensions:

Height - 740mm
Width - 345mm
Depth - 10mm

SELBY 5L STEP CAN



Features:

- 90° opening lid
- Inner wastebasket
- Large foot pedal
- Extra-stable base
- Soft close

Specification:

Polished Steel / Black
0.95kg
0.35mm thickness

Dimensions:

Height - 260mm
Width - 265mm
Depth - 205mm



3L STEP CAN (CROFT / Wastebasket0003)



Features:

- Compact size
- Inner layer wastebasket
- Gripped foot pedal
- Easy to clean
- Soft close

Specification:

Polished Steel / Black / White
0.63kg
0.26mm thickness

Dimensions:

Height - 280mm
Width - 205mm
Depth - 255mm

TOILET BRUSH (SANA / BH0002) / FREE STANDING OR WALL MOUNTED



Features:

- Hygienic silicone bristles
- Anti-drip brush head
- Flexible brush head
- Free standing or wall mountable
- Slimline design

Specification:

Polished Steel & Black / Black
0.30kg

Dimensions:

Height - 390mm
Width - 115mm
Depth - 70mm

ALTON TOILET BRUSH



Features:

- Durable construction
- Nylon bristles
- Glass interior
- Free standing

Specification:

Polished Steel / Black
0.56kg

Dimensions:

Height - 365mm
Width - 102mm
Depth - 102mm



CORBY BATHROOM FIXTURES & FITTINGS

From sleek clothes hooks to elegant towel rails, our fixtures and fittings collection is crafted from premium 304 stainless steel and offered in two sophisticated finishes. Designed to seamlessly compliment our existing range of bathroom wastebaskets, mirrors, and toilet brushes, these pieces bring a cohesive, contemporary edge to any en-suite/bathroom.



HARROGATE TOILET ROLL HOLDER

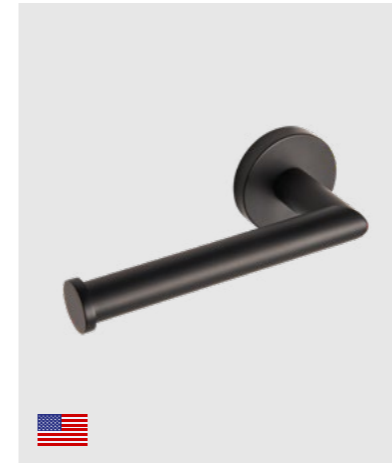

Features:

- Wall mountable
- Concealed fixings
- Durable finish
- Easy to install
- Easy to clean

Specification:

Black / Polished Steel
0.15kg

Dimensions:

Height - 55mm
Width - 165mm
Depth - 65mm



HYGIENE BAG DISPENSER (KENT / HBD0001) / WALL MOUNTED

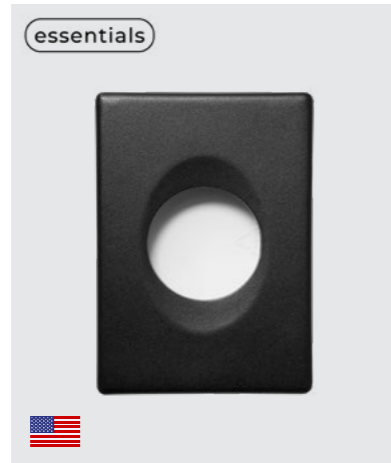
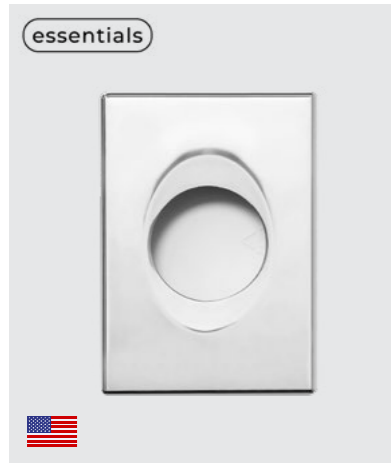

Features:

- Wall mountable
- Detachable base
- ABS construction
- Easy to install
- Easy to clean

Specification:

Chrome / Black
0.08kg

Dimensions:

Height - 138mm
Width - 99mm
Depth - 28mm



HARROGATE TOILET ROLL HOLDER WITH COVER



Features:

- Wall mountable
- Concealed fixings
- Durable finish
- Easy to install
- Easy to clean

Specification:

Black / Polished Steel
0.32kg

Dimensions:

Height - 145mm
Width - 150mm
Depth - 90mm





HARROGATE BATHROOM GRAB RAIL

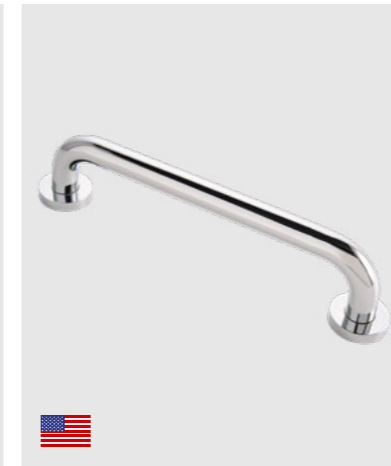
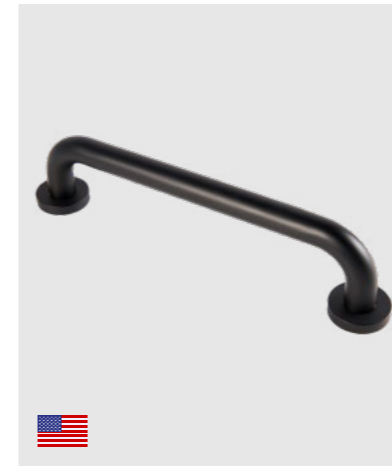

Features:

- Wall mountable
- Concealed fixings
- Durable finish
- Easy to install
- Easy to clean

Specification:

Black / Polished Steel
0.35kg

Dimensions:

Height - mm
Width - 352mm
Depth - 65mm

HARROGATE SINGLE HOOK

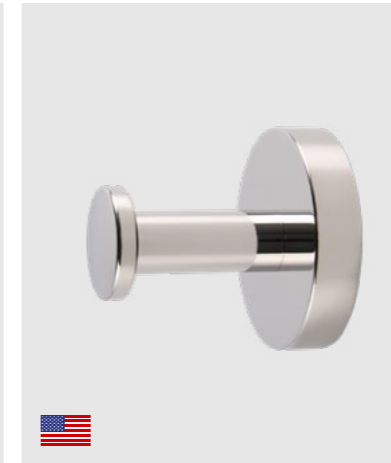
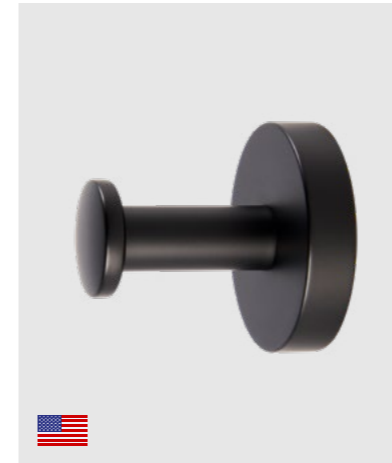

Features:

- Wall mountable
- Concealed fixings
- Durable finish
- Easy to install
- Easy to clean

Specification:

Black / Polished Steel
0.09kg

Dimensions:

Height - 50mm
Width - 50mm
Depth - 50mm

HARROGATE TOWEL RAIL



Features:

- Wall mountable
- Concealed fixings
- Durable finish
- Easy to install
- Easy to clean

Specification:

Black / Polished Steel
0.28kg

Dimensions:

Height - 50mm
Width - 603mm
Depth - 70mm

HARROGATE DOUBLE HOOK

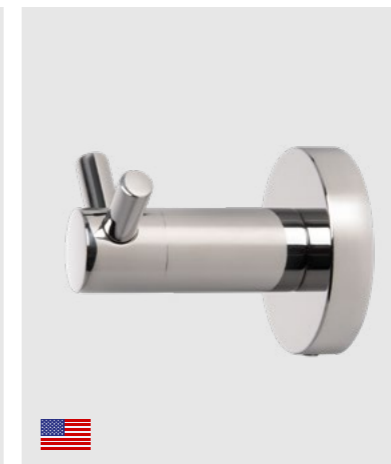

Features:

- Wall mountable
- Concealed fixings
- Durable finish
- Easy to install
- Easy to clean

Specification:

Black / Polished Steel
0.10kg

Dimensions:

Height - 50mm
Width - 63mm
Depth - 50mm

CORBY OF WINDSOR BESPOKE

Corby of Windsor Bespoke is a dedicated service crafted to deliver fully personalised solutions for leading brands and high-impact projects. Whether it's curating unique leatherette colours and textures, customizing wastebasket finishes, or re-colouring electrical appliances to complement your interior scheme, every detail is considered with precision and purpose.

As expert manufacturers of premium wood products, we also design and produce bespoke wooden components for large-scale commercial or hospitality projects. For added distinction, we offer corporate branding customization, ensuring every product becomes a true reflection of your identity.

For more information please contact your Corby of Windsor representative.



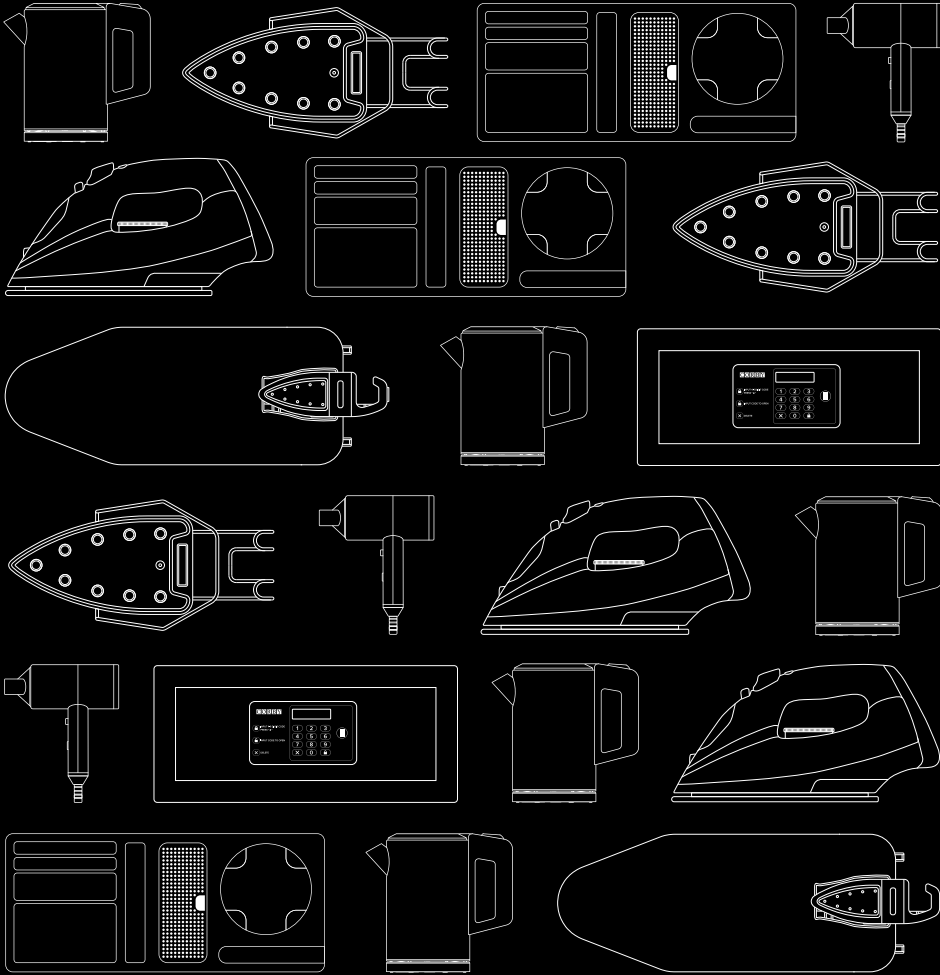

DESIGNED FOR HOTELS

CORBY
of WINDSOR

WWW.CORBYOFWINDSOR.COM

2026/27 Edition